



## Swimming Pool Controllers

BL131

BL132 with Cloud Connectivity

## Dear Customer,

Thank you for choosing a Hanna Instruments® product.

Please read this instruction manual carefully before using this instrument as it provides the necessary information for correct use of this instrument and a precise idea of its versatility.

If you need additional technical information, do not hesitate to e-mail us at [tech@hannainst.com](mailto:tech@hannainst.com).

Visit [www.hannainst.com](http://www.hannainst.com) for more information about Hanna Instruments and our products.

## TABLE OF CONTENTS

<b>1. Preliminary Examination</b> .....	<b>3</b>	<b>6. Setup</b> .....	<b>29</b>
<b>2. Safety Measures</b> .....	<b>3</b>	6.1. User Interface.....	29
<b>3. Specifications</b> .....	<b>4</b>	6.2. General Setup Overview.....	30
3.1. Feature Comparison Table.....	4	6.3. Parameters Setup Overview.....	33
3.2. Technical Specifications.....	4	6.4. BL132 Hanna Cloud Setup.....	41
3.3. HI1036-18XX Probe Specifications.....	7	6.5. Password Protected Settings.....	42
<b>4. Description</b> .....	<b>8</b>	6.6. Analog Outputs (BL131).....	43
4.1. General Description & Intended Use.....	8	<b>7. Operational Guide</b> .....	<b>44</b>
4.2. Functional & Display Description.....	10	7.1. Calibration.....	44
4.3. Wiring.....	13	7.2. Measurement.....	48
4.4. Cable Wiring.....	14	7.3. Overview Control Mode.....	50
<b>5. Installation</b> .....	<b>18</b>	<b>8. Logging</b> .....	<b>53</b>
5.1. General Guidelines.....	18	8.1. Log Recall.....	53
5.2. Installation Steps.....	18	8.2. Event Log.....	55
5.3. Mounting Recommendations for Saddle.....	21	<b>9. Event Management</b> .....	<b>59</b>
5.4. Connecting the Probe to the Pump Controller.....	22	<b>10. Maintenance</b> .....	<b>64</b>
5.5. Installing the Aspiration Filter.....	23	10.1. Electrode Conditioning & Maintenance.....	64
5.6. Installing the Injector.....	23	10.2. Pump Tubing Replacement.....	64
5.7. Flow Cell Installation.....	24	<b>11. Accessories</b> .....	<b>66</b>
5.8. BL132 Cloud Connectivity.....	26	<b>12. Abbreviations</b> .....	<b>69</b>
		<b>Certification</b> .....	<b>70</b>
		<b>Recommendations for Users</b> .....	<b>70</b>
		<b>Warranty</b> .....	<b>70</b>

*All rights are reserved. Reproduction in whole or in part is prohibited without the copyright owner's written consent, Hanna Instruments Inc., Woonsocket, Rhode Island, 02895, USA.*

*Hanna Instruments reserves the right to modify the design, construction, or appearance of its products without advance notice.*

## 1. PRELIMINARY EXAMINATION

Remove the instrument and accessories from the packaging and examine it carefully. For further assistance, please contact your local Hanna Instruments® office or email us at [tech@hannainst.com](mailto:tech@hannainst.com).

BL13X swimming pool controllers are available in two installation configurations:

- BL131-10 and BL132-10  
in-line configuration for direct probe installation into existing piping
- BL131-20 and BL132-20  
flow cell configuration for calibration and probe maintenance whilst maintaining the recirculation pump running

Each instrument is delivered in a cardboard box and is supplied with:

In-line mounting kit	Flow cell mounting kit
<ul style="list-style-type: none"> <li>• HI1036-1802 Combined electrode (pH/ORP/Temperature)</li> <li>• BL130-900 Air temperature probe</li> <li>• Electrode fittings</li> <li>• Electrode saddle, Ø 50 mm pipe (1 pc.)</li> <li>• Injector saddle, Ø 50 mm pipe (2 pcs.)</li> <li>• Injector (2 pcs.)</li> <li>• Peristaltic pump tubing (2 pcs.)</li> <li>• Silicon oil (dropper bottle)</li> <li>• PVC aspiration and injection tubing, 10 m</li> <li>• Aspiration filter (2 pcs.)</li> <li>• 4.01 pH Buffer solution, sachet (3 pcs.)</li> <li>• 7.01 pH Buffer solution, sachet (3 pcs.)</li> <li>• 470 mV ORP test solution, sachet (3 pcs.)</li> <li>• Power cable</li> <li>• Quick reference guide with QR code for manual download</li> <li>• Quality certificates (instrument, probes, accessories)</li> </ul>	<ul style="list-style-type: none"> <li>• HI1036-1802 Combined electrode (pH/ORP/Temperature)</li> <li>• BL130-900 Air temperature probe</li> <li>• Panel mounted flow cell</li> <li>• Flow cell panel</li> <li>• Valve for flow cell connection and fittings (2 pcs.) with 10 m tubing</li> <li>• Valve saddle, Ø 50 mm pipe (2 pcs.)</li> <li>• Injector saddle, Ø 50 mm pipe (2 pcs.)</li> <li>• Injector (2 pcs.)</li> <li>• Peristaltic pump tubing (2 pcs.)</li> <li>• Silicon oil (dropper bottle)</li> <li>• PVC aspiration and injection tubing, 10 m</li> <li>• Aspiration filter (2 pcs.)</li> <li>• Cable gland gaskets</li> <li>• 4.01 pH Buffer solution, sachet (3 pcs.)</li> <li>• 7.01 pH Buffer solution, sachet (3 pcs.)</li> <li>• 470 mV ORP test solution, sachet (3 pcs.)</li> <li>• Power cable</li> <li>• Quick reference guide with QR code for manual download</li> <li>• Quality certificates (instrument, probes, accessories)</li> </ul>

**Note:** Save all packing material until you are sure that the instrument works correctly. Any damaged or defective item must be returned in its original packing material with the supplied accessories.

## 2. SAFETY MEASURES



- Do not use chlorine tablets, granular chlorine, or other non-liquid chlorine applications.
- Do not use the pool controller in a pool utilizing electrolytic chlorine generation (salt electrolysis).
- Do not add stabilizer (e.g. cyanuric acid) to the swimming pool while using the pool controller.  
To remove stabilizer from the pool, the pool must be drained and cleaned.
- Always disconnect the pool controller from power when making electrical connections.



- Do not run other cables with the power cable through the cable gland.

### 3. SPECIFICATIONS

#### 3.1. FEATURE COMPARISON TABLE

	pH measurement	ORP measurement	Acid dosing pump	Chlorine dosing pump	Analog outputs	Hanna Cloud connectivity
BL131	✓	✓	✓	✓	✓	–
BL132	✓	✓	✓	✓	–	✓

#### 3.2. TECHNICAL SPECIFICATIONS

pH	Range	0.00 to 14.00 pH*
	Resolution	0.01 pH
	Accuracy	±0.05 pH (@25 °C / 77 °F)
mV	Range	±2000 mV
	Resolution	1 mV
	Accuracy	±5 mV (@25 °C / 77 °F)
Temperature	Range	–5.0 to 105.0 °C (23.0 to 221.0 °F)*
	Resolution	0.1 °C / 0.1 °F
	Accuracy	±1.0 °C / ±1.8 °F (@25 °C / 77 °F)
Air temperature	Range	–30.0 to 80.0 °C (–22.0 to 176.0 °F)*
	Resolution	0.1 °C / 0.1 °F
	Accuracy	± 0.5°C
Calibration	pH buffer	<ul style="list-style-type: none"> <li>• automatic</li> <li>• two points (4.01 pH, 7.01 pH, 10.01 pH)</li> </ul>
	pH process	<ul style="list-style-type: none"> <li>• adjustable, single point</li> </ul>
	ORP (mV)	<ul style="list-style-type: none"> <li>• adjustable, single point</li> </ul>
Temperature compensation	<ul style="list-style-type: none"> <li>• Automatic temperature compensation for pH</li> </ul>	
	Range	–5.0 to 105.0 °C (23.0 to 221.0 °F)
pH Controller	<ul style="list-style-type: none"> <li>• Delay to start at power-on</li> </ul>	
	<ul style="list-style-type: none"> <li>• Proportional feed using adjustable set point and adjustable proportional band</li> </ul>	
	<ul style="list-style-type: none"> <li>• Overdose protection using the overfeed timer</li> </ul>	
ORP Controller	<ul style="list-style-type: none"> <li>• Delay to start at power-on</li> </ul>	
	<ul style="list-style-type: none"> <li>• Proportional feed using adjustable set point and adjustable proportional band</li> </ul>	
	<ul style="list-style-type: none"> <li>• Overdose protection using the overfeed timer</li> </ul>	
	<ul style="list-style-type: none"> <li>• pH regulator interlocked</li> </ul>	
Alarms	<ul style="list-style-type: none"> <li>• High and Low with enable/disable option for all parameters</li> </ul>	
	<ul style="list-style-type: none"> <li>• Alarm is triggered after a user-specified time</li> </ul>	
Internal pump control	<ul style="list-style-type: none"> <li>• 0.5 to 3.5 L/h (0.13 to 0.92 gal/h) pump flow control</li> </ul>	
	<ul style="list-style-type: none"> <li>• 1 atm (14 psi) maximum output pressure</li> </ul>	
	<ul style="list-style-type: none"> <li>• Manual control for each pump</li> </ul>	
	<ul style="list-style-type: none"> <li>• Magnetic faceplate triggers Hold status when removed (covers internal moving pumps)</li> </ul>	
	<ul style="list-style-type: none"> <li>• Replaceable peristaltic pumps</li> </ul>	
External dosing pump	<ul style="list-style-type: none"> <li>• Relay outputs for external dosing pumps</li> </ul>	

\* The range (pH & temperature) may be limited by the probe's limits.

Pool startup mode	<p>Simplified pool startup procedure</p> <ul style="list-style-type: none"> <li>• Ensures 12 hour dosing to reach a target setpoint</li> <li>• Enabled or disabled manually from the controller menu</li> <li>• Disabled automatically when setpoint is reached or 12 hour timeout has expired</li> </ul>
Freeze protection mode	<ul style="list-style-type: none"> <li>• Air Temperature measurement triggers relay to activate the recirculation pump to prevent water freezing in the pipes</li> </ul>
Log feature	<ul style="list-style-type: none"> <li>• Automatic logging of pH/ORP/air &amp; solution temperature measurements</li> <li>• Configurable logging interval:             <ul style="list-style-type: none"> <li>30 seconds</li> <li>1; 5; 15; 30; 60 minutes</li> </ul> </li> <li>• 300 days logging, depending on selected logging interval (capacity of 100 lots)</li> <li>• Recall data displayed as a plot             <ul style="list-style-type: none"> <li>7 days or 6 hours zoom options</li> <li>overview of (History/Details) measure range registered values i.e. minimum, maximum, average</li> </ul> </li> <li>• Logged event type: setup/alarms/errors/warnings/calibration/power outage (capacity of 100 records, oldest record being overwritten)</li> <li>• Export to USB flash drive (USB-C port) of log files in CSV format</li> </ul>
BL132 Cloud connectivity	<p>The <a href="#">BL132</a> connects to Hanna Cloud via secured connection. Features:</p> <ul style="list-style-type: none"> <li>• Device identity registry</li> <li>• Policy-based authorization of security keys</li> </ul> <p>The <a href="#">BL132</a> sends status information to Hanna Cloud with a defined period.</p> <ul style="list-style-type: none"> <li>• Readings             <ul style="list-style-type: none"> <li>■ pH/ORP/Temperature</li> </ul> </li> <li>• Events             <ul style="list-style-type: none"> <li>■ Alarms/Warnings/Errors</li> </ul> </li> <li>• Peripherals status             <ul style="list-style-type: none"> <li>■ LEDs</li> </ul> </li> <li>• Last dosed acid and chlorine volumes</li> <li>• GLP info</li> </ul> <p>Setup information is sent or configured on the Hanna Cloud.</p> <p><b>Configured data</b></p> <ul style="list-style-type: none"> <li>• Alarm settings</li> <li>• Dosing settings</li> <li>• General settings</li> <li>• Remote Hold mode</li> </ul> <p><b>Read data</b></p> <ul style="list-style-type: none"> <li>• System information:             <ul style="list-style-type: none"> <li>■ Meter – model, FW version, OS version, serial number</li> <li>■ Probe – type, FW version, serial number</li> </ul> </li> </ul> <p>“Remote Hold” mode (configured remotely)</p> <ul style="list-style-type: none"> <li>• emergency mode, remotely triggered via web application</li> <li>• pumps deactivation mode</li> <li>• canceled manually from the controller menu</li> </ul>
BL132 Ethernet input	RJ-45 Ethernet connector (10/100 Mbps connection)

### Additional Specifications

Meter password protection	<ul style="list-style-type: none"> <li>• Password protected setup, calibration, and log recall</li> </ul>
USB-C port	<ul style="list-style-type: none"> <li>• Data export to USB flash drive</li> <li>• Software update</li> </ul>
GLP	pH and ORP
Alarm system	<ul style="list-style-type: none"> <li>• Intuitive alert system based on LED color coded alarm system</li> <li>• Alarm filtering options</li> <li>• Alarm relay control based on user setup filters</li> </ul>
Relays	<ul style="list-style-type: none"> <li>• Alarm relay (SPDT) – activated by selectable pH/ORP/Temperature alarm conditions</li> <li>• Auxiliary Acid/Base pump relay (SPST)</li> <li>• Auxiliary Chlorine pump relay (SPST)</li> <li>• Recirculation pump relay (SPDT)</li> <li>• All relays are fuse protected with 2A time delay 5x20mm cartridge fuses. To be replaced only with time delay glass/ceramic 5x20mm cartridge fuse of same rating.</li> <li>• All relays are rated for 250VAC / 30VDC 2A resistive load.</li> </ul> <p><b>Note:</b> For inductive loads, an appropriate external snubber circuit must be connected to prevent relay contact damage.</p>
Analog outputs (BL131)	<ul style="list-style-type: none"> <li>• 3 × galvanically isolated, user configurable 4-20mA outputs</li> <li>• Current sensing resistor <math>\leq 500 \Omega</math></li> <li>• Accuracy <math>&lt; 0.5 \% FS</math></li> </ul>
Three digital inputs	<ul style="list-style-type: none"> <li>• 3× galvanically isolated, powered contact, digital input</li> <li>• Low level acid / base tank (contact open)</li> <li>• Low level chlorine tank (contact open)</li> <li>• Hold mode (contact open)</li> </ul>
Probe input	<ul style="list-style-type: none"> <li>• Galvanic isolated</li> <li>• RS485 interface</li> <li>• <a href="#">HI1036-1802</a> multiparameter digital probe is equipped with: <ul style="list-style-type: none"> <li>■ pH/ORP/Temperature sensors and a matching pin</li> <li>■ IP65 connector</li> </ul> </li> </ul>
Power	<ul style="list-style-type: none"> <li>• 100 - 240 Vac; 50/60 Hz; 0.7A</li> </ul>
Environment	<ul style="list-style-type: none"> <li>• 0-50 °C (32-122 °F)</li> <li>• Maximum 95 % RH non-condensing</li> </ul>
Dimensions	<ul style="list-style-type: none"> <li>• 245×188×55 mm (73 mm with pumps)</li> <li>• 9.6×7.4×2.2" (2.9" with pumps)</li> </ul>
Weight	1700 g (60 oz)
Casing	Wall mounted, internal pumps, IP65 rated

### 3.3. HI1036-18XX\* PROBE SPECIFICATIONS

Range	pH	0.00 to 12.00 pH
	ORP	±2000 mV
	Temperature	0.0 to 70.0 °C (32.0 to 158.0 °F)
Reference	Ag / AgCl reference electrode (3.5M KCl)	
Junction	Cloth	
Matching pin	Yes	
Body	PVDF	
Top thread	¾" NPT	
Connector	DIN connector	
Maximum pressure @25 °C	3 bar (43.5 psi)	
Probe ordering codes	HI1036-1802	2 m (6'7") cable
	HI1036-1805	5 m (16'5") cable
	HI1036-1810	10 m (32'9") cable
	HI1036-1815	15 m (49'3") cable
	HI1036-1820	20 m (65'7") cable

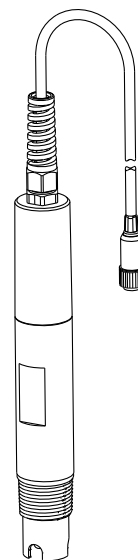

\* XX - cable length options

## 4. DESCRIPTION

### 4.1. GENERAL DESCRIPTION & INTENDED USE

The Hanna Instruments® **BL13X** swimming pool controllers are automatic systems, specially designed to measure and control pH and free-chlorine levels. The modular design of the system supports integration with larger, external pumps for pH and free-chlorine level control of larger pools. The unit is intended for indoor installation (wall mounted or on a panel) and connects to the internet (**BL132**) using an Ethernet cable.

**BL131** is equipped with three Analog Outputs (AO) that allow connection to an external chart recorder or datalogger to monitor any of the three measured parameters. The outputs are scalable, offering increased flexibility and better resolution as needed.

The **BL132** allows remote access to setup parameters and data visualization via Cloud connectivity. All measurements and main events are sent to Hanna Cloud through the Ethernet connection.

The **BL13X** swimming pool controller is an automatic system, but it is advisable that users check the controller and verify pH and free-chlorine levels (in mg/L or ppm) in the pool using a portable colorimeter.

#### Freeze Protection

The controller is equipped with several features to prevent freezing. The software contains special functions using **BL130-900** air-temperature sensor and a configurable air-temperature submenu to protect the water piping against freezing. When the air-temperature drops to a certain value, a relay activates the recirculation pump. The pump remains continuously on and water is circulated into the system until the air temperature reaches above the low setpoint value.

#### Off-Season Maintenance

When the air temperature is **at** or **below** configured freeze threshold limit, Off-Season Mode with Freeze Protection setting enabled, allows the recirculation pump to run continuously. Normal pool control is not running and the **HI1036-1802** electrode can be safely stored away.

#### Probe Compatibility

Any of the controllers can be paired with the **HI1036-1802** electrode. Patch cables may be purchased separately to connect between the electrode and controller up to 20 meters (66 ft).

The electrode incorporates pH, ORP, and temperature sensors along with a matching pin. It was specially designed to detect a broken electrode based on a shifted zero potential value (around 4 pH).

The **HI1036-1802** uses an Ag/AgCl reference with 3.5 M KCl. The ORP values are referenced to it.

Measurement data stored on the probe is transferred to the controller via a digital connection, eliminating noise and static due to high-impedance signals carried by the cable.

#### Compliance Monitoring and Best Practices

**BL13X** swimming pool controller is equipped with an internal datalogger.

Measurement readings are logged periodically, based on configured interval, upon instrument calibration, or when settings are modified. Logged data include pH, ORP, and temperature values (solution and air), last calibration data, setup configuration, and any event data. For review and storage, data can be transferred to a PC using a flash drive and the USB-C port.

#### Significance of Use

The chlorine level is measured based on the ORP or REDOX principle. An increase in the ORP value correlates with an increase in the free-chlorine level. pH and ORP testing are done together for efficient disinfection and control. The efficacy of sanitizers, such as chlorine, depends on a controlled pH value. The ORP value is the most consistent indicator of the sanitizing effectiveness of the pool or spa. Typically, 650-750 mV at 7.2 pH indicates proper water treatment.



### Main features

- Pool startup mode
- Freeze prevention mode
- Magnetic faceplate removal stops internal pumps movement
- Front-facing wiring panel for easy accessibility
- Two internal peristaltic dosing pumps with automatic Proportional pump control
- Manual control for pump priming
- Overtime timers provide overfeed protection
- Level input detection
- Interlocked pH-ORP control
  - ORP control only runs when the pH set point has been reached
- Resumes dosing on restart in case of power failure
- External dosing
  - two relays to control larger, external dispensing pumps
- Air temperature sensor
  - triggers relay to activate the recirculation pump to prevent water freezing in the pipes
- Configurable logging interval
- Controller status, servicing, pump operation (dosing) LED indicators
- Real-time graph display
- USB-C firmware updates
- Programmable alarms
- Password protection
- [BL132](#) – remote settings via Cloud connectivity

### Main benefits

- All-in-one solution for automatic control of pH & chlorine levels
- ORP (chlorine) dosing consent ensures pH value is correct before dosing

## 4.2. FUNCTIONAL & DISPLAY DESCRIPTION

### Front Panel

- Magnetic faceplate encases a custom display and keypad with tactile feedback.
- Two LEDs indicate controller alarm **STATUS** (● ●) and **SERVICE** (☀) conditions. A red LED (✱) indicates fault condition.
- Two blue LEDs (pH and Cl<sub>2</sub>) flash (✱), indicate pump activation.

BL131 front view – faceplate removed

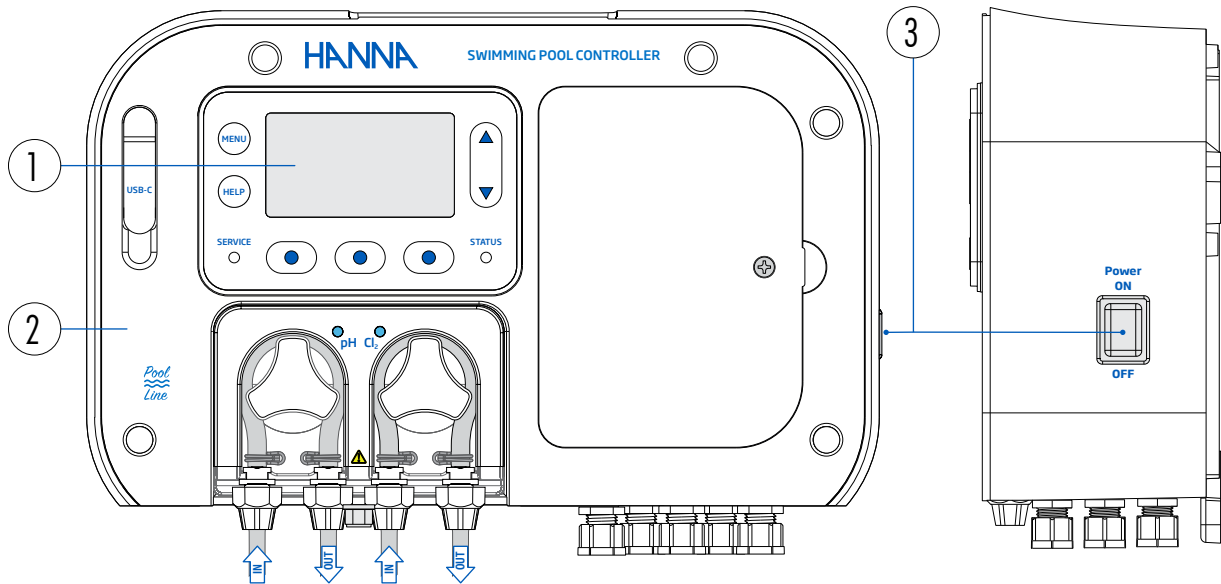

BL131 front view – exposed low-voltage electrical connectors

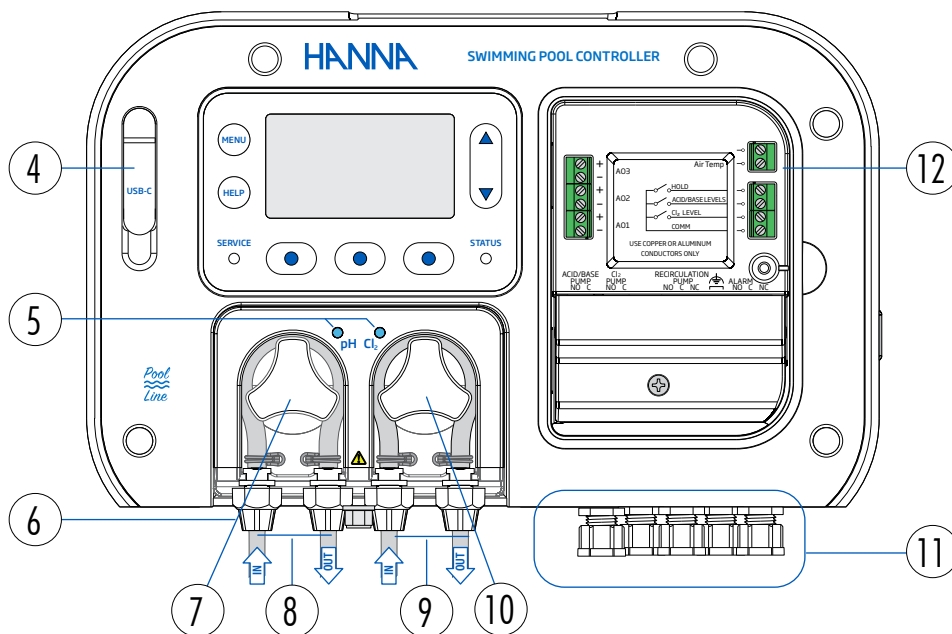

- |   |                                       |
|---|---------------------------------------|
| 1. LCD display and keypad                 | 7. Acid (base) dosing pump            |
| 2. Exposed BL131 unit (faceplate removed) | 8. IN/OUT acid (base)                 |
| 3. Power switch                           | 9. IN/OUT chlorine                    |
| 4. USB-C port                             | 10. Chlorine dosing pump              |
| 5. Pump status LEDs                       | 11. Cable glands                      |
| 6. Pump tubing gland seals                | 12. Low-voltage electrical connectors |

BL132 front view – faceplate removed

Side view

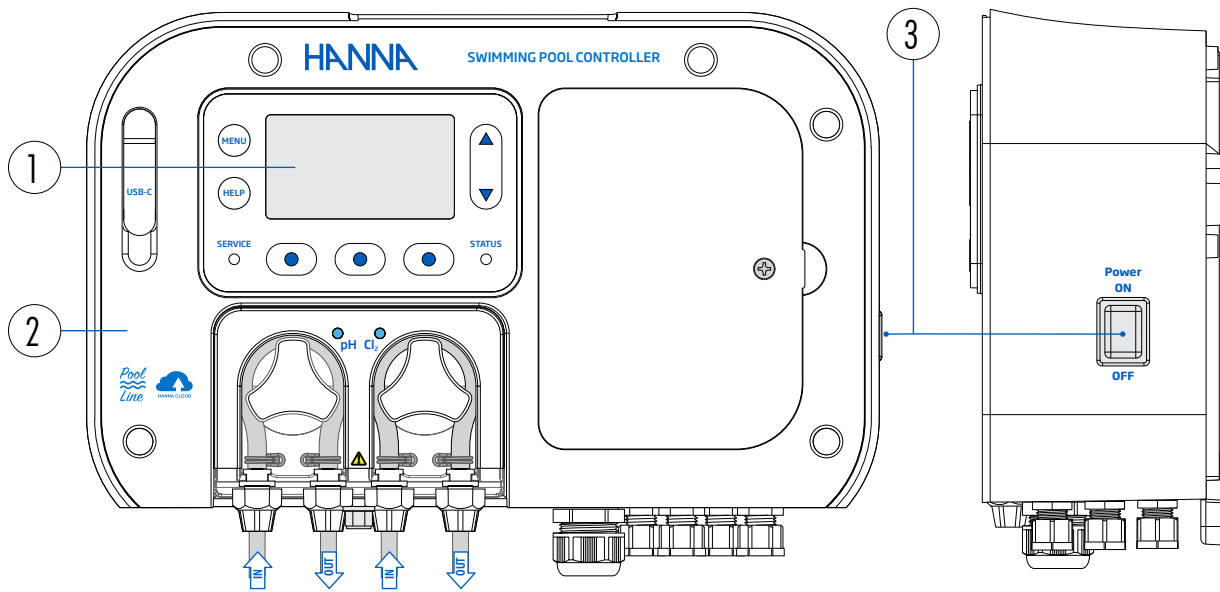

BL132 front view – exposed low-voltage electrical connectors

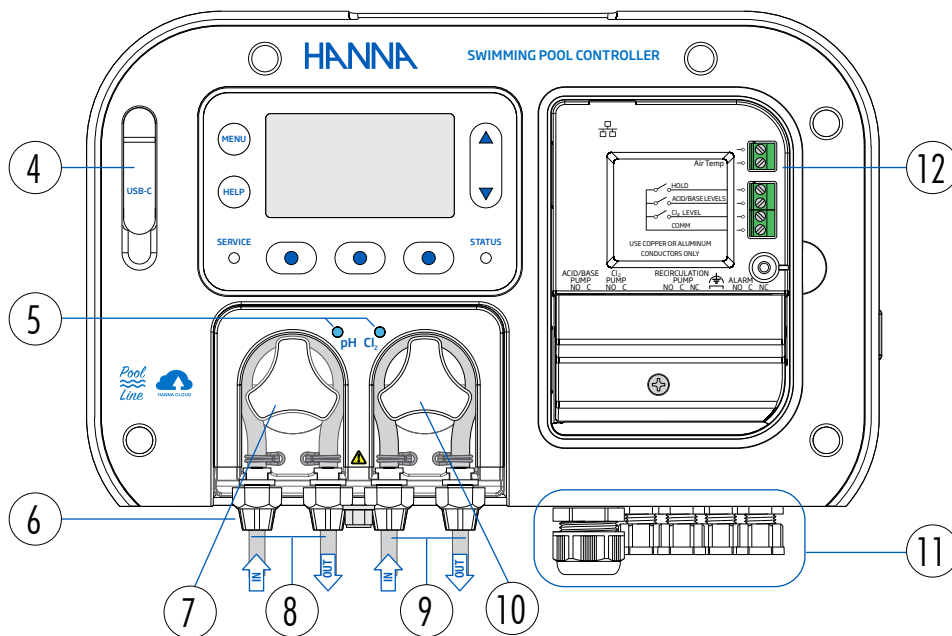

- |   |                                       |
|---|---------------------------------------|
| 1. LCD display and keypad                 | 7. Acid (base) dosing pump            |
| 2. Exposed BL131 unit (faceplate removed) | 8. IN/OUT acid (base)                 |
| 3. Power switch                           | 9. IN/OUT chlorine                    |
| 4. USB-C port                             | 10. Chlorine dosing pump              |
| 5. Pump status LEDs                       | 11. Cable glands                      |
| 6. Pump tubing gland seals                | 12. Low-voltage electrical connectors |

### Keypad description

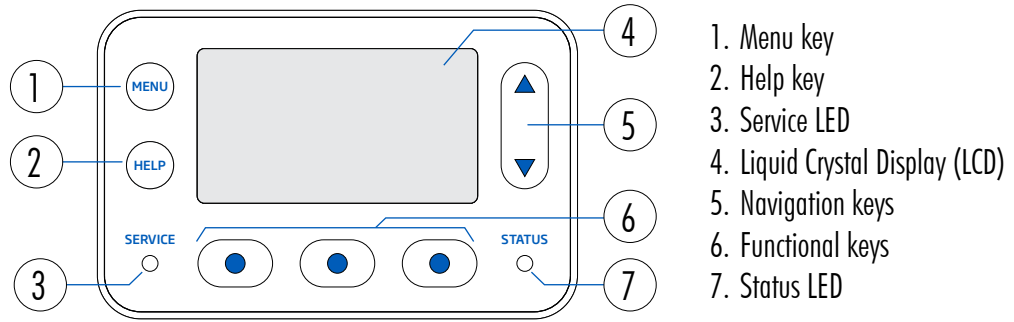

- 1. Menu key
- 2. Help key
- 3. Service LED
- 4. Liquid Crystal Display (LCD)
- 5. Navigation keys
- 6. Functional keys
- 7. Status LED

### Functions

-  Enter setup-edit mode  
Configure pH/ORP/Temperature/Air Temperature options

---

-  Enter/exit Help menu

---

-  When in MENU mode, navigate menu items and/or adjust settings  
When in measurement mode, cycle four parameter screen, single parameter screen, and plot display

---

-  Access contextual functionality

### Back Panel

The controller can be mounted on a wall (1 and 2) or on the flow-cell panel (BL131-20 & BL132-20 only).

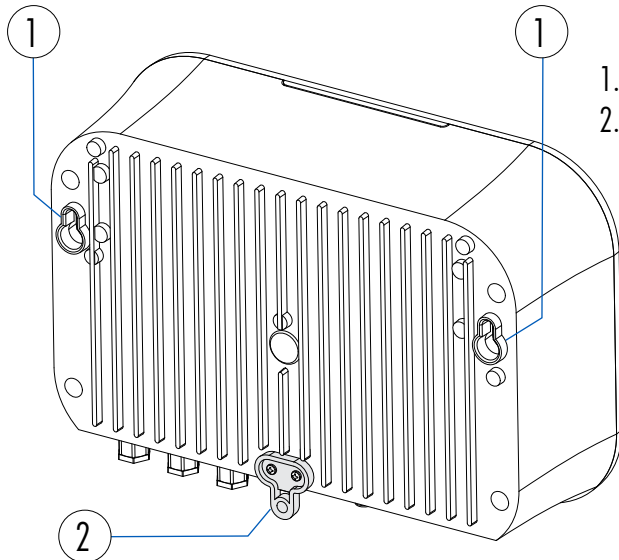

- 1. Mounting holes
- 2. Hook plate

Ordering code: [BL130-411](#)

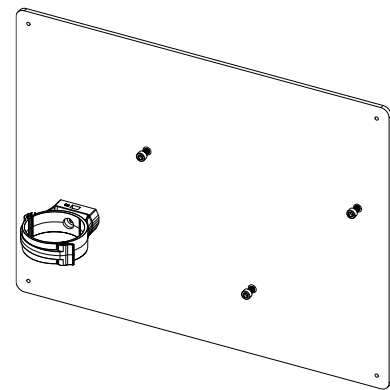

Maximum hole / screw size  
Ø 6.0 mm (0.236")

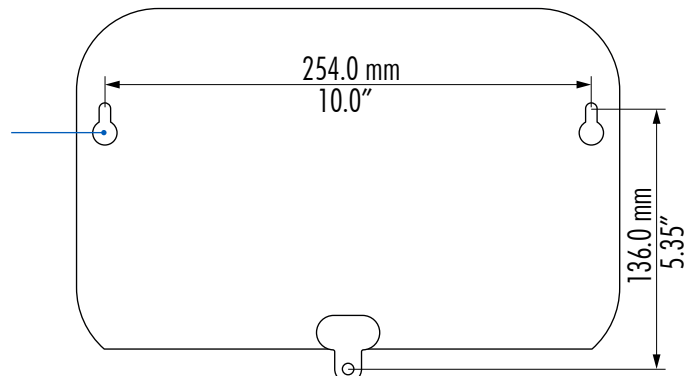

### 4.3. WIRING

1. Remove the magnetic faceplate (A) to access the electrical connectors cover (B).

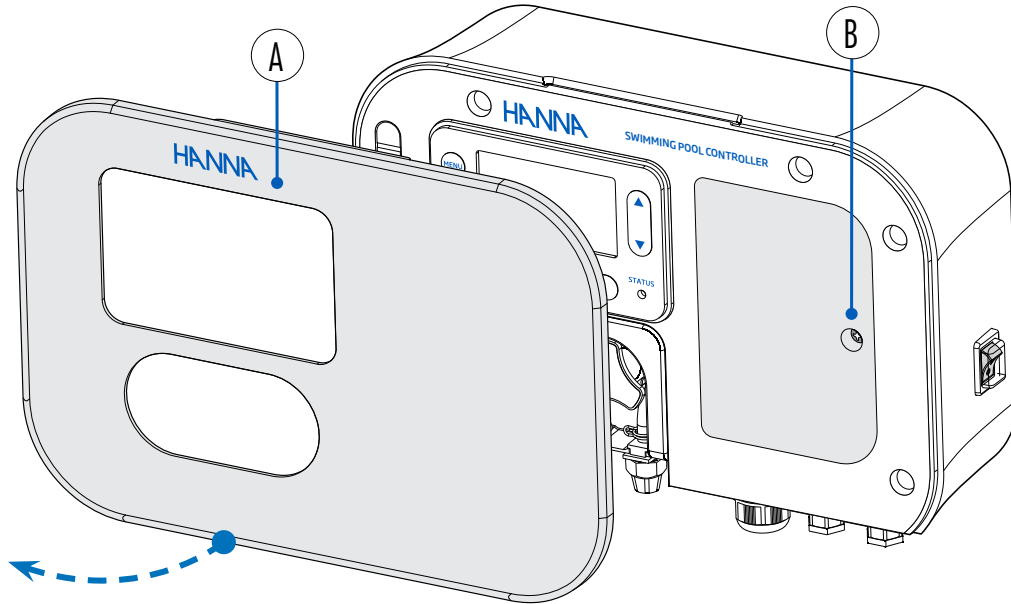

2. Use a screwdriver to remove the single screw (C) attaching the panel cover.  
**Note:** See exposed **low-voltage** electrical connectors.
3. Use a screwdriver to remove the single screw attaching the high-voltage electrical connectors cover (D).

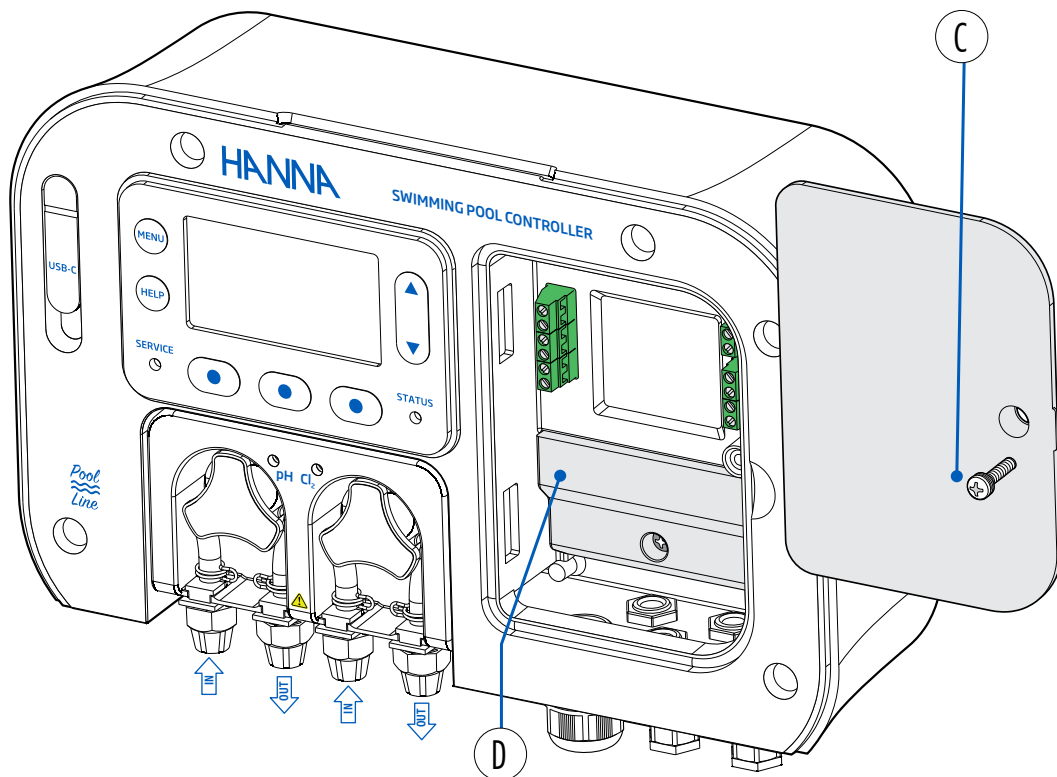

## 4.4. CABLE WIRING

### BL131 front view — exposed electrical connectors

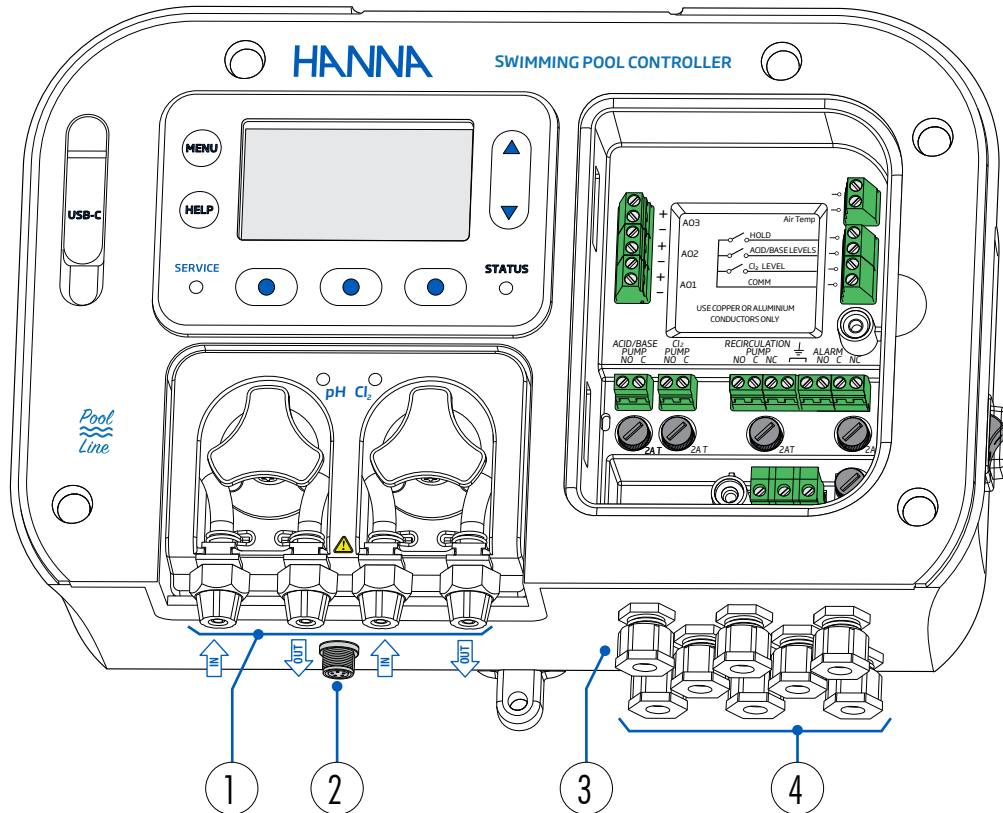



1. Pump tubing gland seals
2. Probe DIN connector
3. Cable gland (analog output)
4. Cable gland (power, digital input, alarm relay)

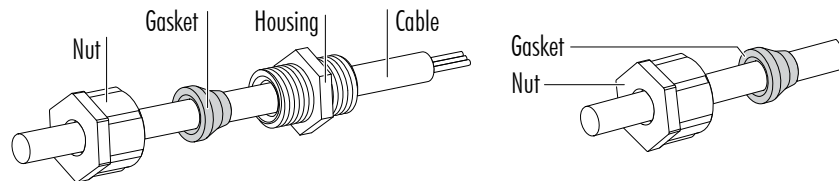

*Do not run power cabling through the same opening as other cables.  
All unused openings must be sealed with conduit plugs.*



- Unscrew the nut of the selected cable gland
- Remove the blank plug. 
- Thread the cable through the nut and the gasket, then into the housing. 
- Feed the cables enough for the wires to reach their ports.
- Insert the wire into the designated port and tighten the screw until the wire is properly torqued.
- Follow lead markings to ensure that output leads are wired to the correct position on the main board.
- Insert the gasket into the housing.
- Turn the nut clockwise to tighten.

**Note:** Use a six - conductor wire cable for Analog Output wiring.

## BL132 front view – exposed electrical connectors

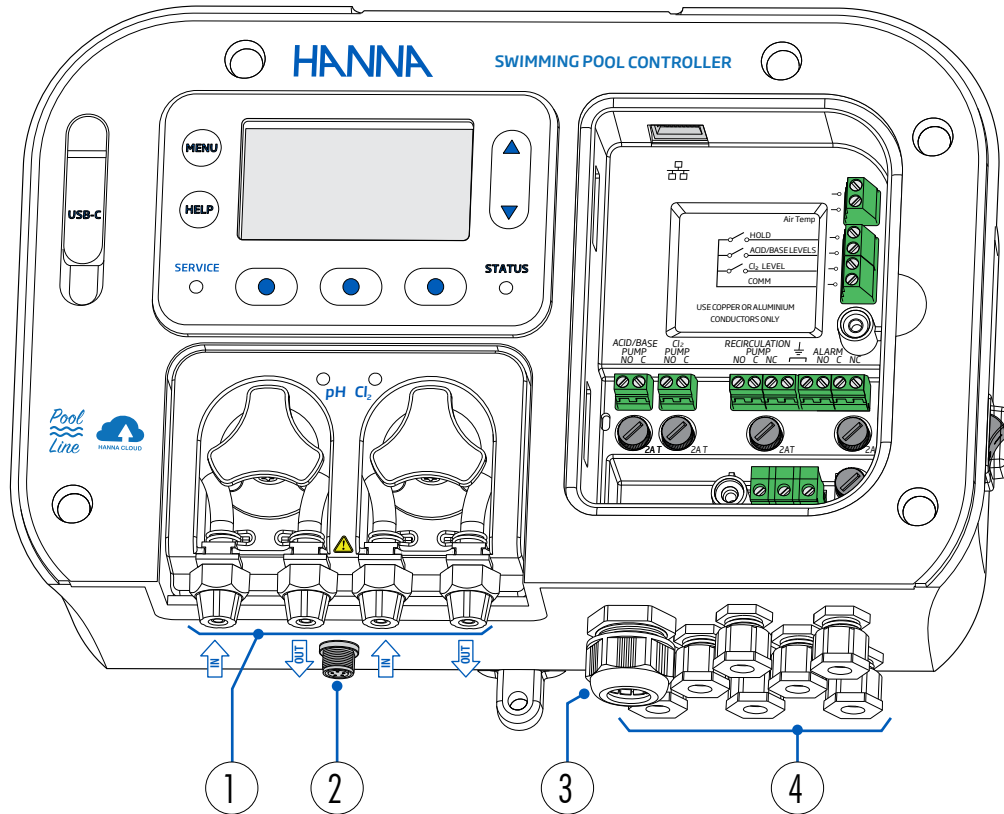

1. Pump tubing gland seals
2. Probe DIN connector
3. Cable gland (Ethernet wiring)
4. Cable gland (power, digital input, alarm relay)



*Do not run power cabling through the same opening as other cables.  
All unused openings must be sealed with conduit plugs.*

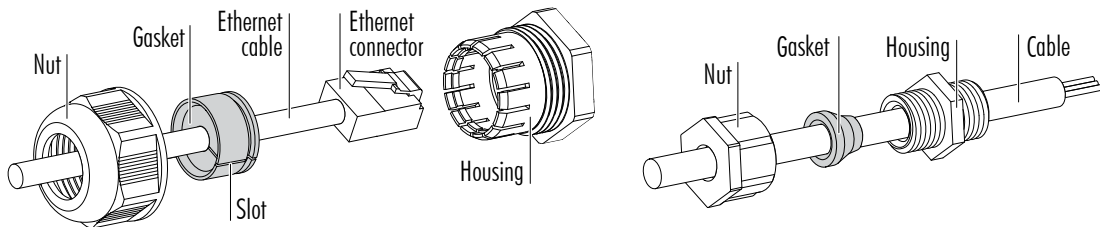

- Unscrew the nut of the selected cable gland.
- Remove the blank plug. 

**Note:** Remove the single gasket if using two or three way wire gaskets (3).

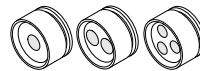

- Thread the cable through the nut, gasket, and into the housing.
- Feed the cable enough for the wires (Ethernet connector) to reach the selected port.
- Insert the wire into the designated port and tighten the screw until the wire is properly torqued.
- Insert the gasket into the housing.
- Turn the nut clockwise to tighten.

### Low-Voltage Electrical Connectors

 **Warning!** Always disconnect the pool controller from power when making electrical connections.

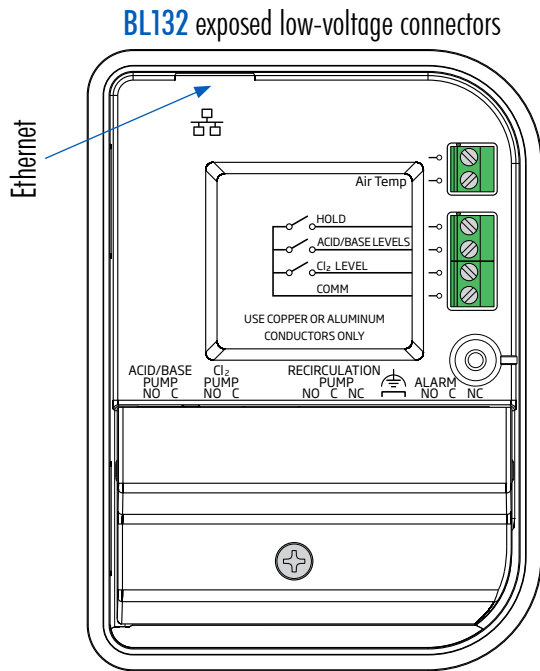
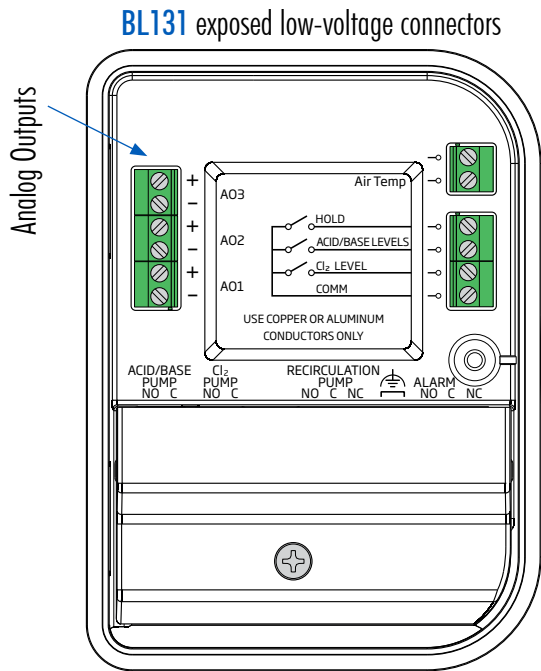

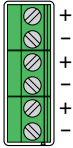
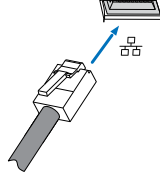
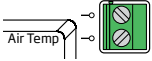
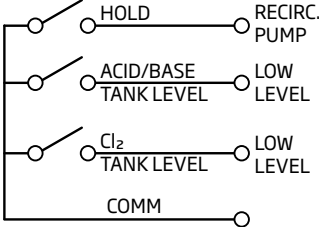
<p><b>ANALOG OUTPUTS (BL131)</b></p> 	<p><b>ETHERNET (BL132)</b></p> <p>RJ-45 connector</p> 
<p><b>TEMPERATURE INPUT</b></p> <p>Air temperature sensor</p> 	<p><b>DIGITAL INPUTS</b></p>  <p>HOLD — RECIRC. PUMP ACID/BASE TANK LEVEL — LOW LEVEL Cl<sub>2</sub> TANK LEVEL — LOW LEVEL COMM</p>

### Power Connectors (high-voltage)

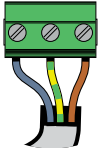
<b>POWER INPUT</b>		
	<b>N</b>	Neutral
	<b>PE</b>	Protective Earth (Protective Ground)
	<b>L</b>	Line



## Pumps and Alarms Connectors



**Warning!** Always disconnect the pool controller from power when adjusting electrical connections.

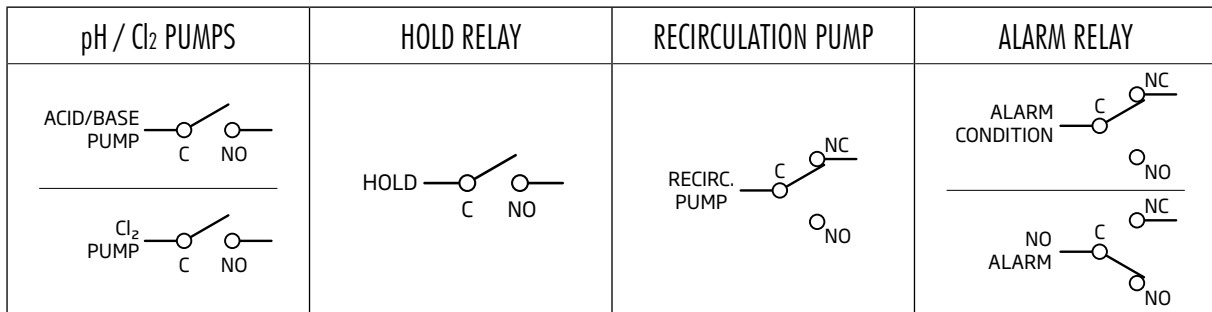
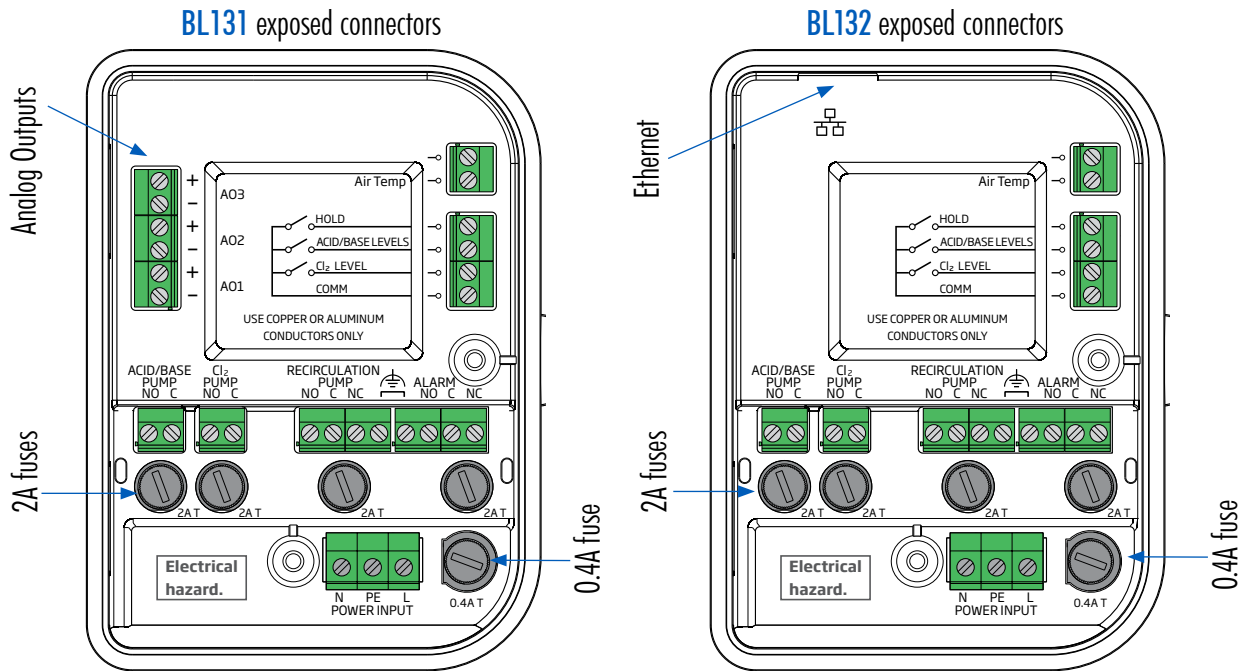

## Fuse Replacement



**Warning!** Always turn off and disconnect from power before replacing a fuse.  
Only replace with glass or ceramic, time-delay fuse of same rating.  
Do not replace the fuse as maintenance.

- The instrument is protected by a 0.4A time-delay 5×20 mm cartridge fuse.
- All relays are protected with 2A time-delay 5×20 mm cartridge fuses.

## Steps

- Remove the high-voltage electrical connectors cover. Identify the blown fuse.
- Insert a flathead screwdriver into a screw's slot diagonally. Carefully turn counter-clockwise to release.
- Gently pry the cap upwards to remove.
- Gently pull the blown fuse straight out to remove.
- Take a new fuse and place it into the cap.
  - power fuse type: 0.4 A slow-blow
  - pump/alarm relay fuse type: 2 A
- Align the cap with the slot. Press gently down and turn clockwise to lock in place.

## 5. INSTALLATION

Two installation configurations:

- In-line
  - The probe is placed in the saddle, mounted in pipe after the pool filter.
- Panel mounted flow cell
  - The probe is mounted in the flow cell, close to the controller.
  - The water sample is directed to the flow cell via a small-diameter sample line with appropriate connections (provided).
  - The water circulation can be stopped by closing the valve on the inlet while maintenance or calibration are performed.

### 5.1. GENERAL GUIDELINES

Electrical connection, installation, start-up, operation, and maintenance must be carried out by specialized personnel only.

- Select controller location so that it is shielded from direct sunlight, dripping water and excess vibrations.
- Keep flow rate as constant as possible for optimum sensor operation.
- Install cable gland fittings and plugs as needed, to properly seal the pump controller.
- For optimal operation, all tubing, cables, saddles and fittings must be properly connected.
- For in-line installation, the probe saddle should be positioned after the pool filter, within 2 m distance.

**Caution!** Use gloves, protective clothing, and eye protection goggles when working with injectors and tubing.

**Note:** Determine if a flow detector, alarm relays or analog outputs (BL131 only) will be used before mounting flow cell panel or pool controller, as access to using internal pumps is needed.

### 5.2. INSTALLATION STEPS

**Note:** Recirculation pump must be off.

1. Check the acid and chlorine reagent tank level.
2. Calibrate the probe before use in the system.
3. Mount the probe into saddle (in-line configuration) or in a flow cell.
4. Mount the injector saddles (see procedure).
5. Measure and cut required length to connect tubing between filter in chemical tank and pump's inlet (aspiration tubing).  
Suggested maximum length for vertical installations is 5 m (16.4 ft)
6. Measure and cut required length to connect tubing between pump's outlet and injector (injection tubing).
7. Check the level sensor's functionality (if used).
8. Check hold input functionality (if used).

### In-Line Installation Overview & Components Table

Illustrated reference of a generic, in-line installation scheme using internal pumps with the relevant components

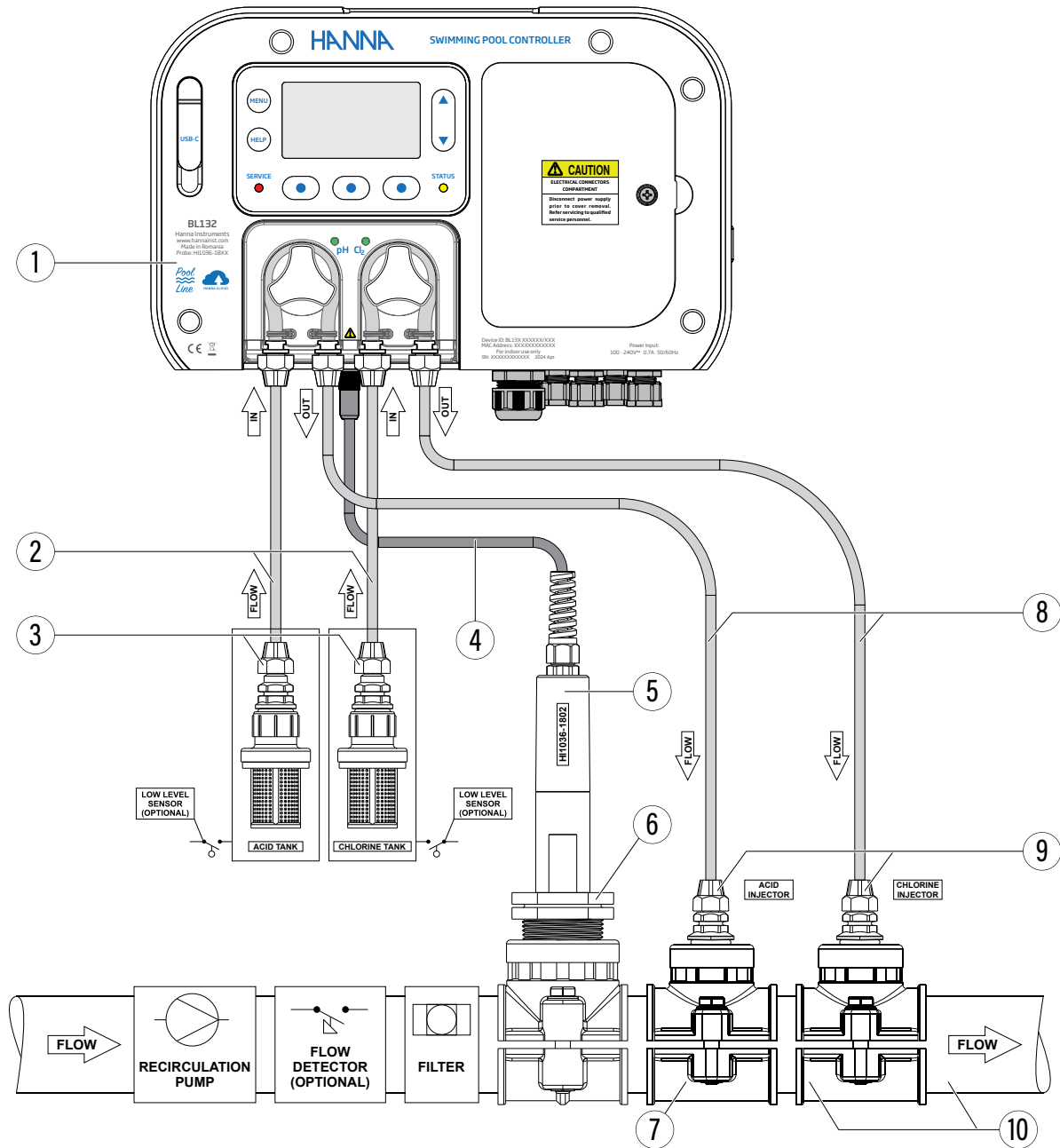

Position	Component description
1	Pool controller
2	PVC tubing for pump input
3	Aspiration filter
4	Electrode cable
5	pH/ORP/temperature electrode
6	Electrode fitting
7	Probe saddle for pipe, using 1 1/4" thread
8	PVC tubing for pump output
9	Injector, 1/2" thread
10	Injector saddle for pipe, using 1/2" thread

### Flow Cell Installation Overview & Components Table

Illustrated reference of a generic, flow cell installation scheme with the relevant components  
 The maximum pressure of the flow cell system is 3 atm (44 psi).

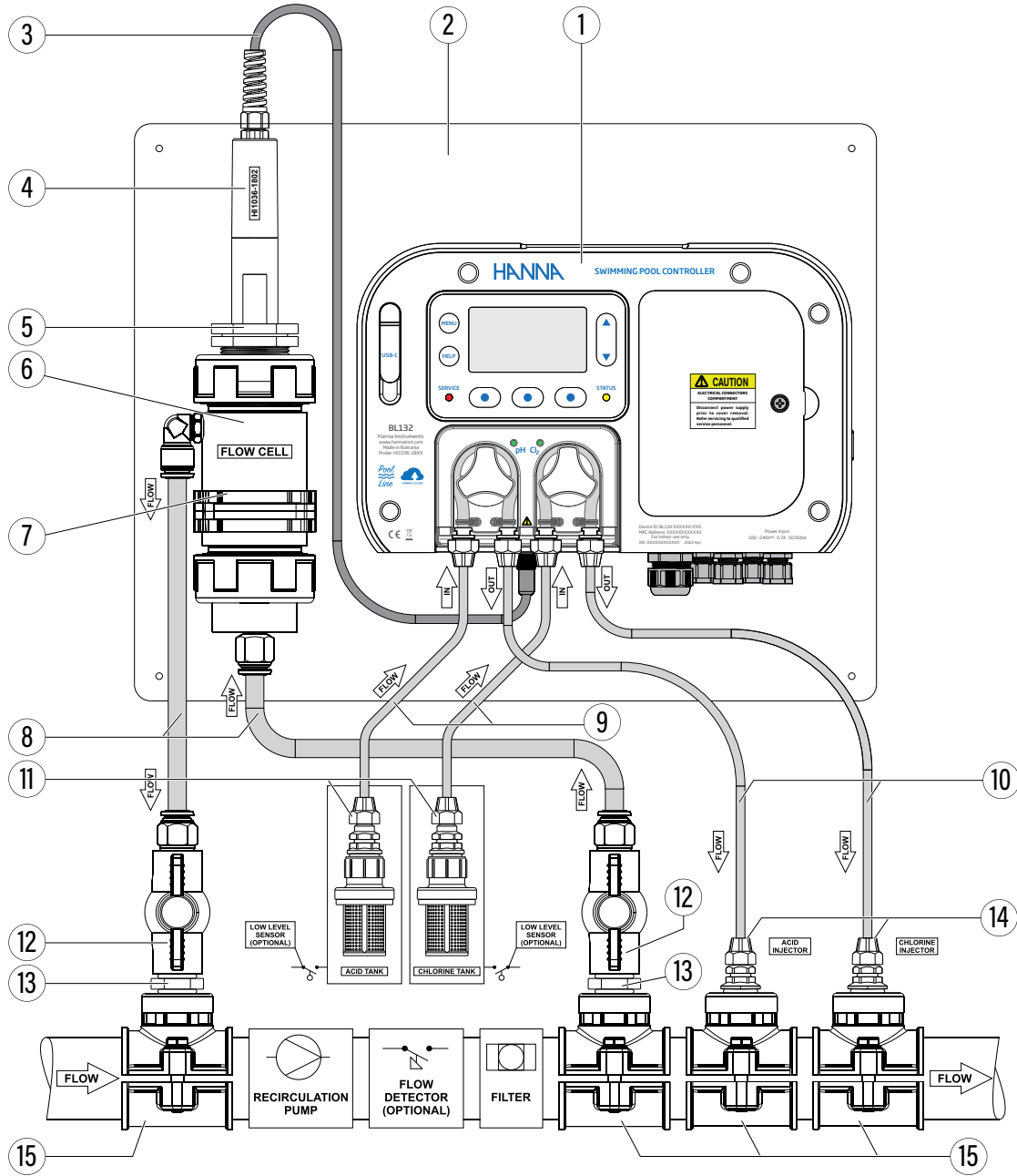

Position	Component description
1	Pool controller
2	Mounting panel
3	Electrode cable
4	pH/ORP/temperature electrode
5	Flow cell adapter
6	Flow cell
7	Flow cell panel mount
8	Flow cell tubing

Position	Component description
9	PVC tubing for pump input
10	PVC tubing for pump output
11	Aspiration filters
12	Flow cell valve
13	Plastic nipple, 1/2"
14	Injector, 1/2" thread
15	Injector saddle for pipe, using 1/2" thread

### 5.3. MOUNTING RECOMMENDATIONS FOR SADDLE

- Select required drill size. See table below for dimension details.

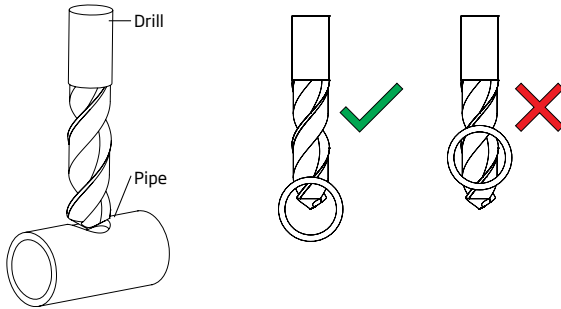

- Place the upper part of the saddle (5) on top of the pipe (3) with the seal (4) placed over the hole.
- Take the lower part of the saddle (2), together with inserted nuts (1) and align it under the upper part.
- Insert the screws (7) with washers (6) through the holes and hand tighten into the mounted nuts.
- With all the screws (7) in place, use a wrench to carefully tighten.
- Place the O-ring (8) provided into the upper saddle.

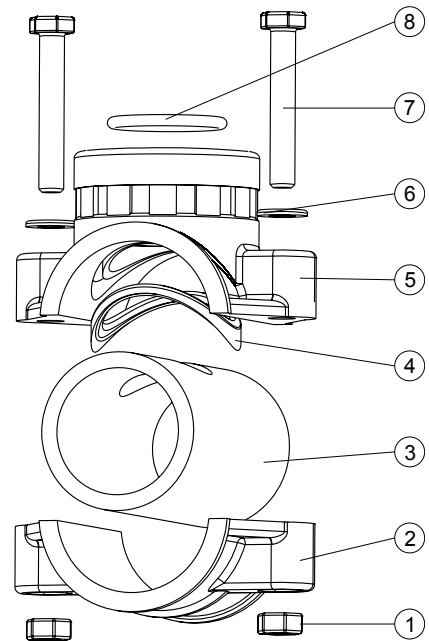

Probe Saddle (In-line Configuration)		Thread Size	Drill Size
BL120-550	Ø 50 mm pipe	1 ¼" thread	29 mm - 32 mm / 1.14" - 1.26"
BL120-563	Ø 63 mm pipe	1 ¼" thread	29 mm - 32 mm / 1.14" - 1.26"
BL120-575	Ø 75 mm pipe	1 ¼" thread	29 mm - 32 mm / 1.14" - 1.26"

Valve Fittings (Flow Cell Configuration)		Thread Size	Drill Size
BL120-450	Ø 50 mm pipe	½" thread	20 mm - 25.4 mm / 0.79" - 1.00"
BL120-463	Ø 63 mm pipe	½" thread	20 mm - 25.4 mm / 0.79" - 1.00"
BL120-475	Ø 75 mm pipe	½" thread	20 mm - 25.4 mm / 0.79" - 1.00"

Injector Saddle		Thread Size	Drill Size
BL120-250	Ø 50 mm pipe	½" thread	20 mm - 25.4 mm / 0.79" - 1.00"
BL120-263	Ø 63 mm pipe	½" thread	20 mm - 25.4 mm / 0.79" - 1.00"
BL120-275	Ø 75 mm pipe	½" thread	20 mm - 25.4 mm / 0.79" - 1.00"

## 5.4. CONNECTING THE PROBE TO THE PUMP CONTROLLER

Ensure the probe is connected and calibrated before installation.

1. Remove protective cap and verify the O-ring is in place.

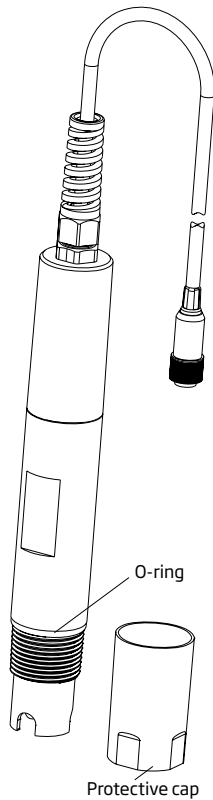

2. Insert the nut onto the probe.

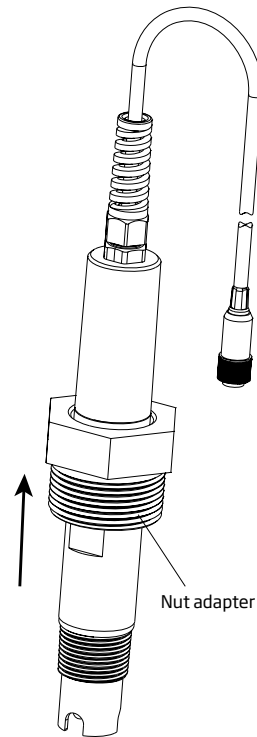

3. Carefully screw the adapter onto the probe taking care not to damage the O-ring.

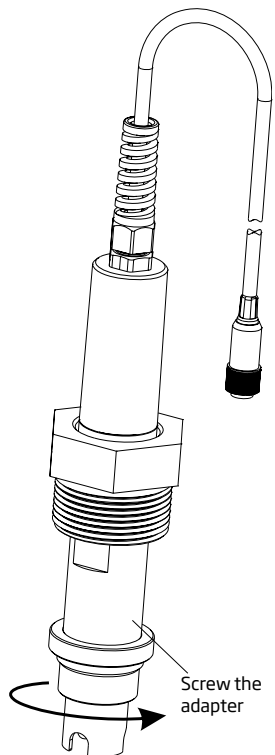

4. Insert the probe with the adapter and screw it carefully into the saddle.

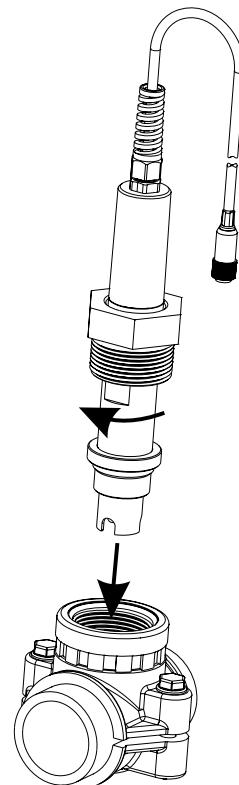

## 5.5. INSTALLING THE ASPIRATION FILTER

The aspiration filter is used in the reagent tank to filter and prevent debris from entering the tubing.

- Cut the required length of aspiration tubing (flexible) to reach between peristaltic pump inlet and aspiration filter.
- The nut should be placed on the tubing before it is connected. Place the end of tubing on the filter.
- The compression fitting has to be screwed in until tight on the filter.
- Slide the compression fitting from the peristaltic pump inlet onto the tubing.
- Slide the end of tubing over the fitting of the peristaltic pump tubing.
- Slide compression fitting up over tubing.
- Tighten the fitting to secure in place.

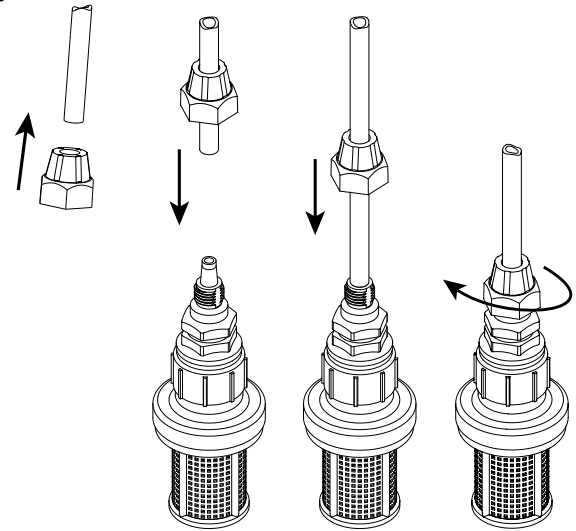

## 5.6. INSTALLING THE INJECTOR

- Cut required length of injection tubing to reach between injector saddle and outlet of peristaltic pump.
- Place the compression fitting nut on the tubing.
- Place the end of tubing on the injector.
- The compression fitting has to be screwed in until tight on the injector.
- Screw the injector in the saddle.
- Slide the compression fitting from the peristaltic pump outlet onto the tubing.
- Slide the end of tubing over the fitting of the peristaltic pump tubing.
- Slide compression fitting up over tubing.
- Tighten the fitting to secure in place.

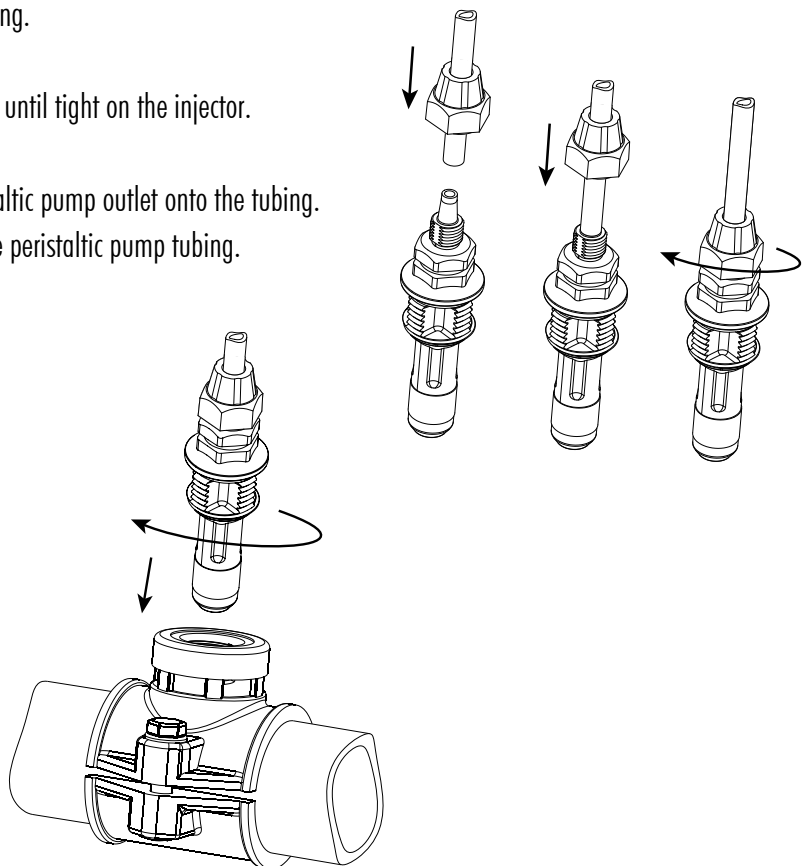

## 5.7. FLOW CELL INSTALLATION

In a flow cell configuration the water flows from the inlet valve to the flow cell and returns in the line via the outlet valve.

### PART A Preparing the inlet and outlet valve assemblies

- Mount the saddle for flow cell inlet and outlet valve (follow mounting recommendations for saddle).
- Sparingly lubricate two O-rings (2) with a thin film of grease and mount them on both sides of the nipple (1).
- Screw the nipple into the saddle (3).
- Screw the valve (4) into the open end of the nipple mounted into the saddle. Make sure it is tight and the lever is facing forward so that it can be operated.
- Carefully screw the straight tubing fitting (5) into the valve, taking care not to damage the O-ring.
- Insert the tubing (6) in the straight tubing fitting (5).

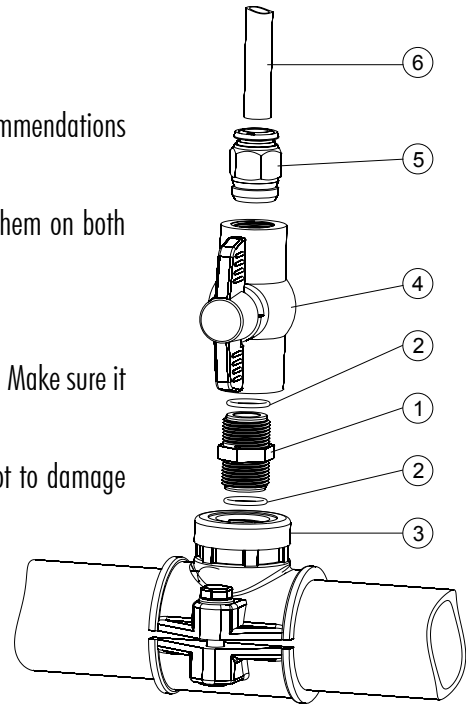

### PART B Assembling and mounting the flow cell

- Place an O-ring (4) onto the flow cell cap (5) and insert the cap to the end of the flow cell tubing (2) without the hole on the side. Screw the flow cell nut (3) into place over the flow cell cap.
- Screw the straight tubing fitting (6) into the hole of the flow cell cap.
- Place an O-ring (4) onto the flow cell cap (1) and insert the cap onto the end of the flow cell tubing (2) with the hole in the side. Screw the flow cell nut (3) into place over the flow cell cap (1).
- Screw the elbow tubing fitting (7) into the side hole of the flow cell tubing (2).
- Place the supplied O-ring (8) into the flow cell cap (1).

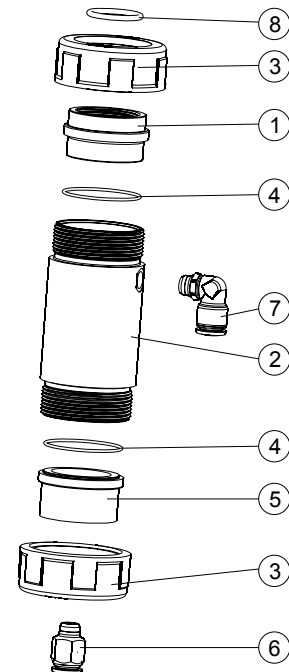



**PART C** Connecting the probe to the controller

- Remove the protective cap and verify the O-ring (2) is in place.
- Insert the nut (5) into the probe. Carefully screw the adapter (4) into the probe, paying attention not to damage the O-ring.
- Mount the collar (7) onto the panel with the supplied screw.
- Insert the assembled flow cell (see part B) into the collar (7) and overlap the two collar wings. Hand press the overlapped wings until the collar clicks into position.
- Carefully insert the probe (3) into the flow cell, paying attention not to damage the O-ring. The adapter (4) mounted on the probe should now be inside the flow cell.
- Screw the nut (3) enough to secure the electrode and flow cell assembly in place.
- Insert the aspiration valve tubing (6a) into the saddle.
- Insert the dispensing valve tubing (6b) into the saddle.

**Note:** Prepare and calibrate the probe prior to installing in the flow cell.

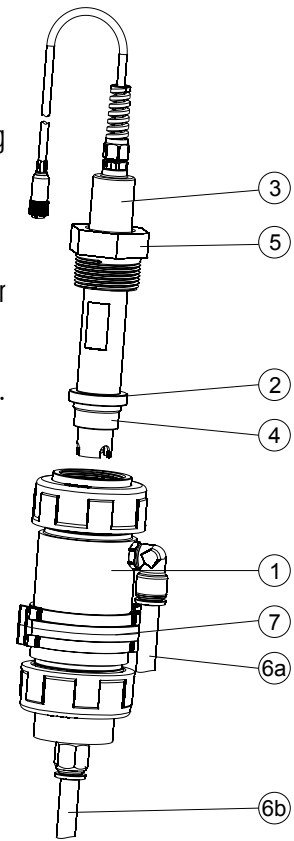

## 5.8. BL132 CLOUD CONNECTIVITY

The Hanna Cloud is a web-based application that connects users to the [BL132](#) Swimming Pool Controller. Multiple registered devices can be registered to a single Hanna Cloud account.

Measurements, trends, history, device settings, alarms, and messages are transmitted to the user's "Dashboard", as the instrument controls the process.

An account's primary user can upgrade firmware and change configuration settings of the displayed meter.

Multiple secondary users may also be added to one's device, to monitor measurements and receive notifications from the controller.

Secondary users have rights selected by the primary user i.e. access to remote Hold and access to settings configuration.

The screenshot shows a dialog box titled "Assign secondary user Woonsocket". It contains an input field for "Email ID". Below the input field are two checkboxes: "Settings Access" and "Remote Hold Access". At the bottom of the dialog, there are two buttons: "Assign secondary user" and "Close".

### Data Protection

The Hanna Cloud safeguards personal data by incorporating technical and administrative security measures that reduce risks of loss or misuse. These include (but are not limited to) a secured connection, device identity registration, and password encryption.

**Note:** Collected data is stored in Hanna Cloud for three months.

### Create a User Account

- Go to [www.hannacloud.com](http://www.hannacloud.com) or download the Hanna Lab App for iOS and Android devices.
- Click on the  icon.
- Click on **Create Account** and fill in the email and password information.

The screenshot shows the Hanna Instruments login page. It has a blue header with the Hanna Instruments logo and a language dropdown menu set to "English". Below the header are two input fields: "Email ID\*" and "Password\*", each with an eye icon for visibility. A "Sign In" button is positioned to the right of the password field. At the bottom of the page, there are two links: "Create Account" and "Forgot Password?".

- Read the Hanna Instruments Privacy Policy and click Create Account. A validation email will be sent to the registered email. Follow the link to access your account. Confirm the user account before logging in.

**Note:** After login, the Hanna Cloud user guide can be accessed for detailed information on Hanna Cloud functionality.

## Remote update using Hanna Cloud (primary user)

We aim to constantly improve our products and offer professional enhanced product features. As such, Hanna Instruments® periodically releases firmware updates.

1. Go to [www.hannacloud.com](http://www.hannacloud.com)
2. Log into your account.
3. Locate the device on the dashboard.  
The firmware for BL132 can be updated remotely.
4. If an update is available for the device the "Firmware update available" message will be displayed below the header.

Firmware update available

5. Clicking on the banner shortcuts to the update tab.  
Alternatively, click on Setting gear icon (⚙️) and select the "Update Firmware" tab.
6. Select the firmware version to update and press Update Firmware.

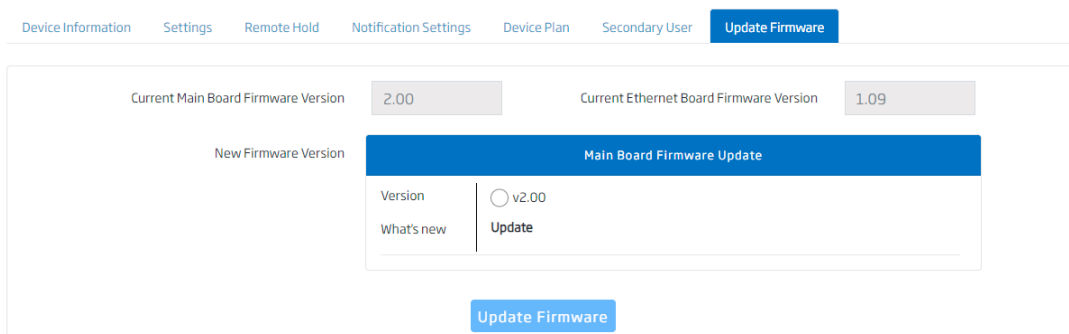

7. The update request will be confirmed and update will be installed.  
**Note:** If the firmware is up to date the message "Firmware up to date." will be displayed in the box.
8. The firmware update may take 8 to 10 minutes to complete. The device restarts automatically when update is complete.
9. At the completion, a banner with "Firmware update successful" is displayed.

**Note:** During the remote firmware update these screens will appear on instrument. When the installation is complete, the transmission icon will show a solid communications image (📶).

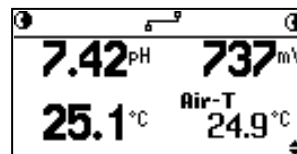
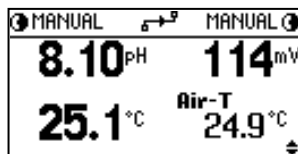
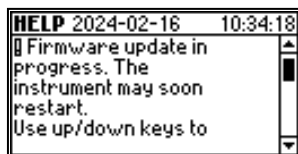

## USB Firmware Update

### Requirements

- Firmware update package file
- USB 2.0 or 3.2 flash drive

### Procedure

1. Copy the firmware update package file to the root directory of a USB-C drive.
2. Power off the meter.
3. Plug in the USB-C drive.
4. Power on the meter. Following message is displayed.



5. Press **MENU** key before the counter has elapsed. Following message is displayed.



6. Press **YES**.
7. Following messages confirm in-progress update procedure. Please wait while the system is updated.

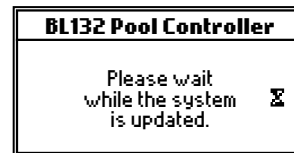
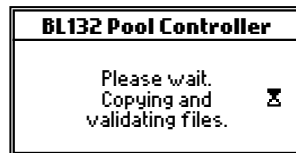

8. Update complete screen confirms firmware update completion.



9. Wait until countdown (bottom right corner) reaches 0. Remove the USB drive. The device enters measurement screen.
10. Press **MENU** key and navigate to General Settings.
11. Press **Setup** and navigate to Controller Info.
12. Press **View**. Check main board and language version match newly installed firmware

## 6. SETUP

### 6.1. USER INTERFACE

The pool controller menu is grouped into following categories:

- Acid (Base) Pump (R) control: OFF/AUTO, ON 10s
- Chlorine (Cl<sub>2</sub>) Pump (R) control: OFF/AUTO, ON 10s
- pH Options: CAL, Setup, GLP
- ORP Options: CAL, Setup, GLP
- Temperature Options: Setup
- Air Temperature: Setup
- Log Recall: Log Files, Plot, Events
- BL132 Hanna Cloud Options: Status, Setup, R-Hold
- General: Setup

### BL13X Activity Overview Diagram

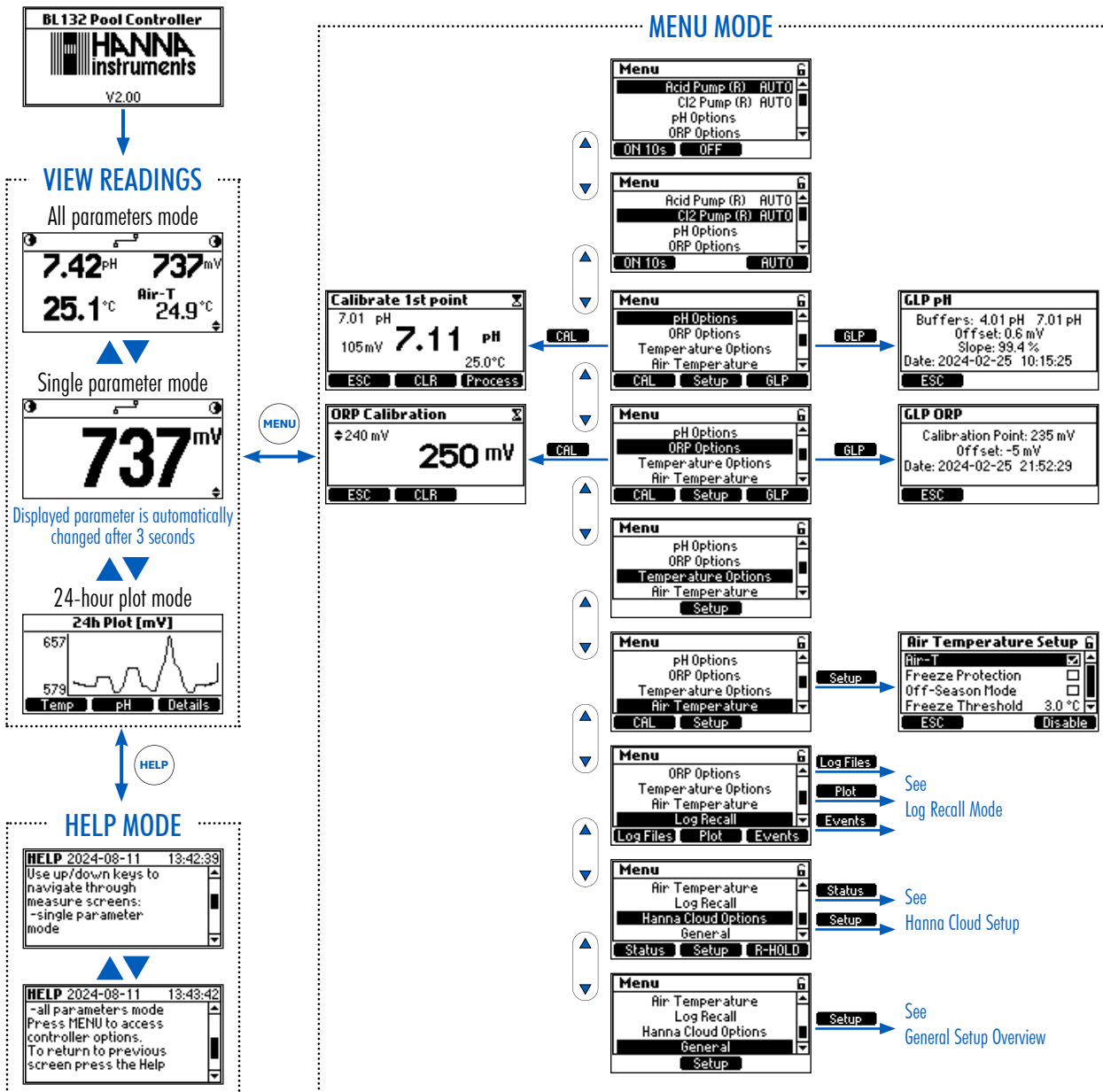

## BL13X Log Recall Overview

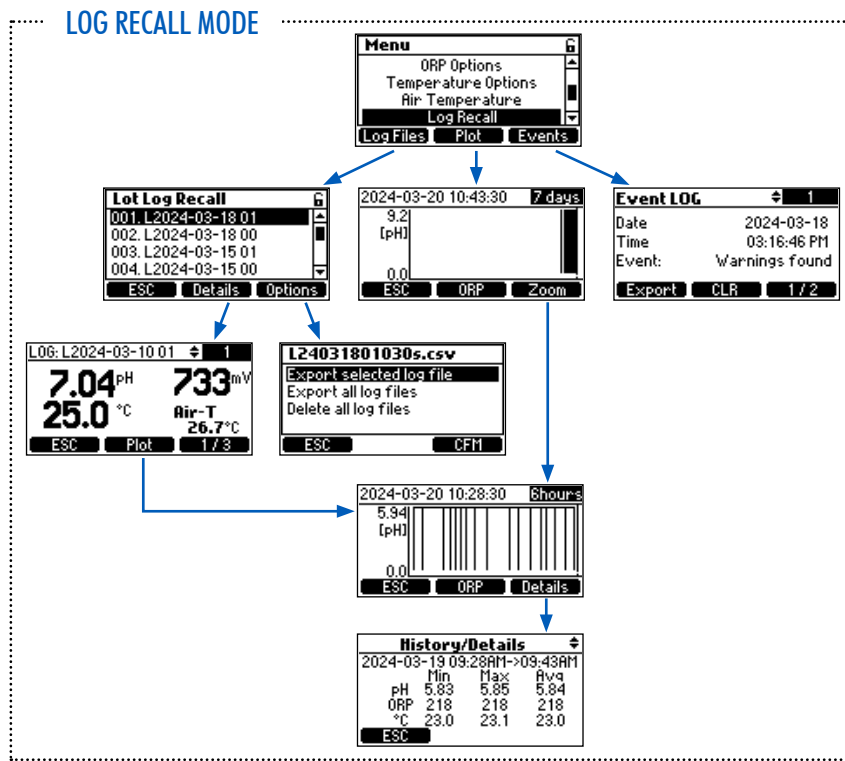

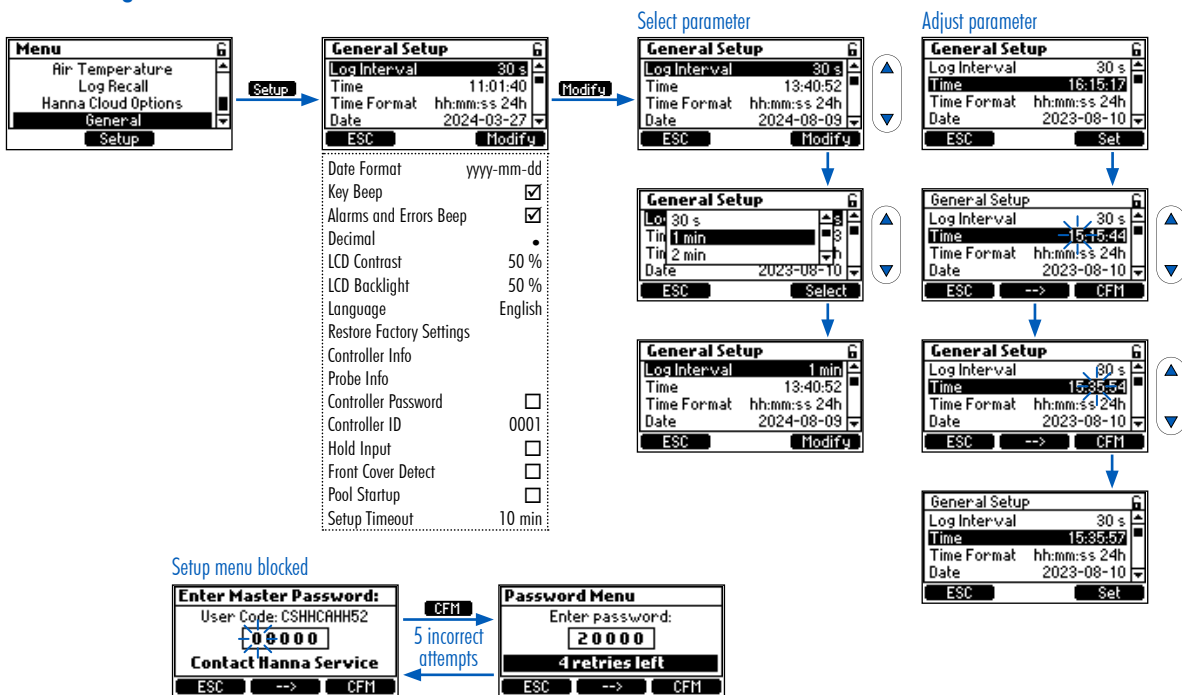

## 6.2. GENERAL SETUP OVERVIEW

### Menu Items Diagram



## Configurable Options

General Settings	Range/Options	Default	Description/Menu Navigation
Log Interval	30 sec. 1 min.; 5 min.; 15 min.; 30 min.; 60 min.	30 sec.	<ul style="list-style-type: none"> <li>• With item selected, press <b>Modify</b> for options drop-down list.</li> <li>• Press ▼▲ keys to navigate options.</li> <li>• Press <b>Select</b> to save.</li> </ul>
Time	Current set times	N/A	<ul style="list-style-type: none"> <li>• With item selected, press <b>Set</b> to modify.</li> <li>• With selected value flashing, press  key to navigate right between digits; use ▼▲ keys to increase or decrease the value.</li> <li>• Press <b>CFM</b> to save.</li> </ul>
Time Format	hh:mm:ss 24h hh:mm:ss 12h	hh:mm:ss 24h	<ul style="list-style-type: none"> <li>• With item selected, press <b>Modify</b> for options drop-down list.</li> <li>• Press ▼▲ keys to navigate options.</li> <li>• Press <b>Select</b> to save.</li> </ul>
Date	year/month/date	N/A	<ul style="list-style-type: none"> <li>• With item selected, press <b>Set</b> to modify.</li> <li>• With selected value flashing, press  key to navigate right between year/month/day.</li> <li>• Press ▼▲ keys to increase or decrease the value (keep the key pressed to fast-forward).</li> <li>• Press <b>CFM</b> to save.</li> </ul>
Date Format	yyyy-mm-dd dd-mm-yyyy mm-dd-yyyy yyyy/mm/dd dd/mm/yyyy mm/dd/yyyy	yyyy-mm-dd	<ul style="list-style-type: none"> <li>• With item selected, press <b>Modify</b> for options drop-down list.</li> <li>• Press ▼▲ keys to navigate options.</li> <li>• Press <b>Select</b> to save.</li> </ul>
Key Beep	<input checked="" type="checkbox"/> Enable <input type="checkbox"/> Disable	Disabled	<ul style="list-style-type: none"> <li>• With item selected, press the toggle switch to enable or disable option. An acoustic signal confirms option enabled.</li> </ul>
Alarms and Errors Beep	<input checked="" type="checkbox"/> Enable <input type="checkbox"/> Disable	Enabled	The check mark confirms option as enabled.
Decimal	Point / Comma	Point	<p>This option is a field separator for Log files. It may be set as comma ";" or full stop "." depending on region preferences.</p> <ul style="list-style-type: none"> <li>• With item selected, press the toggle switch to configure option.</li> </ul>
LCD Contrast	0 % to 100 % / 1 %	50 %	<ul style="list-style-type: none"> <li>• With item selected press <b>Set</b> for the contrast control slider to display.</li> <li>• Press ▼▲ keys to drag the slider along the bar (keep key pressed to fast forward).</li> <li>• Press <b>CFM</b> to save.</li> </ul>
LCD Backlight	0 % to 100 % / 1 %	50 %	<ul style="list-style-type: none"> <li>• With item selected press <b>Set</b> to display the brightness control slider.</li> <li>• Press ▼▲ keys to drag the slider along the bar (keep key pressed to fast forward).</li> <li>• Press <b>CFM</b> to save.</li> </ul>
Language	English, Deutsch, Español, Français, Italiano, Nederlands, Português	English	<p>This option allows the user to customize the meter to preferred language.</p> <ul style="list-style-type: none"> <li>• With item selected, press <b>Modify</b> for options drop-down list.</li> <li>• Press ▼▲ keys to navigate options.</li> <li>• Press <b>Select</b> to save.</li> </ul>
Restore Factory Settings	N/A	N/A	<p>This option allows the user to erase all user settings and reset the instrument to the default factory settings.</p> <ul style="list-style-type: none"> <li>• With item selected, press <b>Set</b> to restore default settings.</li> </ul>

General Settings	Range/Options	Default	Description/Menu Navigation
Controller Info	N/A	N/A	With item selected, press <b>View</b> to display model version, model number, language version, and serial number.
Probe Info	N/A	N/A	With item selected, press <b>View</b> to display model version, language version, and serial number.
Controller Password	<input checked="" type="checkbox"/> Enable <input type="checkbox"/> Disable	Disabled	<ul style="list-style-type: none"> <li>• With item selected, press <b>Modify</b>.</li> <li>• Press <b>▼▲</b> keys to increment/decrement the digit (displayed flashing).</li> <li>• Press <b>→←</b> key to navigate right between digits.</li> <li>• Press <b>CFM</b> to save.</li> </ul>
Controller ID	0 to 9999/1	0001	<ul style="list-style-type: none"> <li>• With item selected, press <b>Set</b> to modify.</li> <li>• Press <b>▼▲</b> keys to increase or decrease the value (keep key pressed to fast forward).</li> <li>• Press <b>CFM</b> to save.</li> </ul>
Hold Input*	<input checked="" type="checkbox"/> Enable <input type="checkbox"/> Disable	Disabled	When Enable is selected, the Hold is configurable. Hold may be triggered with a user-supplied Hold relay switch or remotely (BL132).
Front Cover Detect	<input checked="" type="checkbox"/> Enable <input type="checkbox"/> Disable	Enabled	This option enabled safely stops internal pumps movement when the magnetic faceplate is removed. If this option is disabled, and internal pumps are utilized, pump LED's will blink rapidly as a warning to use caution around the moving pumps. The check mark confirms option as enabled.
Pool Startup	<input checked="" type="checkbox"/> Enable <input type="checkbox"/> Disable	Disabled	<p>Pool Startup allows the control pumps to run for a total of 12 hours with proportional control to reach the programmed Set Points for pH and ORP.</p> <p>During this period, alarm conditions will not stop the pumps. The timer continuously counts down during this period. The timer decreases during pump "On periods" or "Off periods". The timer stops when both Set Points are reached (pH first followed by ORP) or the 12 hour window expires.</p> <p>A pump may stop briefly within the proportional band. Remote Hold can also stop pump action. During these times the counter continues counting down in the background.</p> <p>If Set Points are reached within the 12 hour window, the meter switches to direct control mode and the Pool Startup counter stops.</p> <p>If Set Points are not reached during Pool Startup period, the meter reverts to direct control mode with overtime, and may turn off control pumps.</p> <p>Pool Startup becomes disabled if power is lost, Set Points are reached, the pool setup timer expired, or feature is disabled.</p> <p>The check mark confirms option as enabled.</p>
Setup Timeout	1 to 30 min./1 min.	10 min.	Timer used to return the device to the measurement/control mode when no menu changes have occurred within the set time period.

\* Feature has to be enabled in Setup.

An (optional) in-line flow sensor has to be attached to the controller Hold input (see 6.4 WIRING section for digital input connections).

When the recirculation pump doesn't work, the flow sensor output should be open to trigger the HOLD mode and inactivate dosing pumps.



### Hold Input submenu when option is enabled in General Settings

The Hold Input submenu is used to configure what should happen when the Hold Input is triggered.

- If Enabled, the Alarm will trigger when the Hold is triggered.
- If Disabled, the Alarm will not trigger when the Hold is enabled.

Option is useful for routine evening shut down without alarms. It can also be used to configure a remote hold feature that uses a digital input trigger.

Hold Input submenu item	Range/Options	Default	Description/Menu Navigation
Alarm	<input checked="" type="checkbox"/> Enable <input type="checkbox"/> Disable	Disabled	<ul style="list-style-type: none"> <li>• With item selected, press the toggle switch to enable or disable option. The check mark confirms option as enabled.</li> </ul>
Contact	Open/Close	Open	

**Note:** During operation the Hold will use the same delay time as was set for startup (see pH Options/StartupDosingDelay).

### 6.3. PARAMETERS SETUP OVERVIEW

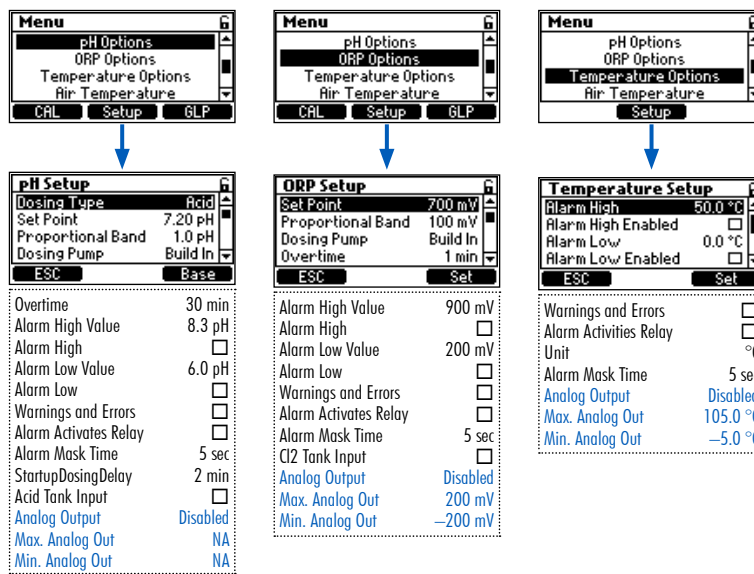

**Note:** The analog outputs – A01, A02, A03 – are only available for BL131.

### Protection against unwarranted changes: save configuration changes

To protect against accidental changes, device enters Hold and instrument prompts for confirmation.

Select YES to save changes or NO to return to previously configured values.

## pH Configurable Options

pH Settings	Range/Options	Default	Description/Menu Navigation
Dosing Type	Base/Acid	Acid	<ul style="list-style-type: none"> <li>With item selected, press the toggle switch to configure option.</li> </ul>
Set Point	6.00 to 8.00 pH /0.01pH	7.2 pH	<p>The BL meter regulates the pH to the pH value set in this parameter.</p> <ul style="list-style-type: none"> <li>With item selected, press <b>Set</b> to modify.</li> <li>With value flashing, press ▼▲ keys to change the value.</li> <li>Press <b>CFM</b> key to save.</li> </ul>
Proportional Band	0.1 to 2.0 pH/0.1 pH	1.0 pH	<p>The Proportional Band is pH zone adjacent to the Set Point where the pump "Off time" increases as the measurement approaches the Set Point. This is used to prevent over dosing.</p> <ul style="list-style-type: none"> <li>With item selected, press <b>Set</b> to modify.</li> <li>With value flashing, press ▼▲ keys to change the value.</li> <li>Press <b>CFM</b> key to save.</li> </ul>
Dosing Pump	Buit In Remote Dual	Buit In	<p>Setup flow rate for acid/base dosing pump Range: 0.5 to 3.5 l/h Default 2.2 l/h (0.1 l/h increment)</p>
Overtime <i>Note: Set Point must be configured</i>	1 to 360 min.	30 min.	<p>Overtime is the maximum time in minutes the pH pump is permitted to continuously run outside the Proportional Band. Within the band, the time is increased as the pump "Off time" increases approaching the Set Point.</p> <ul style="list-style-type: none"> <li>With item selected, press <b>Set</b> to modify.</li> <li>With value flashing, press ▼▲ keys to change the value.</li> <li>Press <b>CFM</b> key to save.</li> </ul>
Alarm High Value	(pH Low+0.1) to 14.0 pH Acid /0.1 pH	8.3 pH	<p>The High Alarm Value for pH is the minimum pH value that will trigger an alarm status and stop the control pumps (unless in Pool Startup mode). Mask time will delay alarm activation.* Status (●) and service (●) LEDs are active.</p> <ul style="list-style-type: none"> <li>With item selected, press <b>Set</b> to modify.</li> <li>With value flashing, press ▼▲ keys to change the value.</li> <li>Press <b>CFM</b> key to save.</li> </ul>
Alarm High	<input checked="" type="checkbox"/> Enable <input type="checkbox"/> Disable	Disabled	<ul style="list-style-type: none"> <li>With item selected, press the toggle switch to enable or disable pH high alarm option</li> </ul>
Alarm Low Value	0.0 to (pH High-0.1) pH Acid /0.1 pH	6.0 pH	<p>If enabled, Alarm Low Value for pH is the maximum pH value that will trigger an alarm status and stop the control pumps (unless in Pool Startup mode). Mask time will delay alarm activation.** Status (●) and service (●) LEDs are active.</p> <ul style="list-style-type: none"> <li>With item selected, press <b>Set</b> to modify.</li> <li>With value flashing, press ▼▲ keys to change the value.</li> <li>Press <b>CFM</b> key to save.</li> </ul>
Alarm Low	<input checked="" type="checkbox"/> Enable <input type="checkbox"/> Disable	Disabled	<ul style="list-style-type: none"> <li>With item selected, press the toggle switch to enable or disable pH low alarm option</li> </ul>

\* The minimum adjustable value for alarm high is related to the value assigned to alarm low (if enabled).

\*\* The maximum adjustable value of alarm low is related to alarm high value (if enabled).

pH Settings	Range/Options	Default	Description/Menu Navigation
Warnings and Errors	<input checked="" type="checkbox"/> Enable <input type="checkbox"/> Disable	Disabled	<p>The check mark confirms option as enabled.            If enabled, warnings and errors will be flagging during operation.  <b>A warning</b> is an event generated when erroneous conditions appear; and when measured values or parameter values are outside the expected range.  <b>An error</b> is an critical event that requires technical support.            A list of these events are listed later in this manual.</p>
Alarm Activates Relay	<input checked="" type="checkbox"/> Enable <input type="checkbox"/> Disable	Disabled	<p>The check mark confirms option as enabled.            If enabled, the Alarm Relay will be activated if an error or warning condition is detected.</p> <ul style="list-style-type: none"> <li>• With item selected press the toggle switch to enable or disable the relay control for pH events.</li> </ul>
Alarm Mask Time	5 to 999 sec./1 sec.	5 sec.	<p>Mask Time is an alarm delay timer that prevents immediate alarm activation for the time set.</p> <ul style="list-style-type: none"> <li>• With item selected, press <b>Set</b> to modify.</li> <li>• Press <b>▼▲</b> keys to configure value.</li> <li>• Press <b>CFM</b> key to save.</li> </ul>
Startup Dosing Delay	1 to 180 min./1 min.	2 min.	<p>This timer is used after powering on the controller and prevents pump dosing for this time period.</p> <ul style="list-style-type: none"> <li>• With item selected, press <b>Set</b> to modify.</li> <li>• Press <b>▼▲</b> keys to configure value.</li> <li>• Press <b>CFM</b> key to save.</li> </ul>
Acid Tank Input Base Tank Input	<input checked="" type="checkbox"/> Enable <input type="checkbox"/> Disable	Disabled	<p>Enables/Disables the low input level in acid tank.            When enabled, works in conjunction with a level detector (user supplied) to notify user when acid level is low and will require replenishment.</p>
Analog Output <a href="#">BL131</a>	Disabled A01, A02, A03	Disabled	<p>Analog Outputs are used as part of process control system.            Disabled indicates that analog output has not been allocated to any function.            A01, A02, A03 assign an analog output to a pH reading.</p>
Max. Analog Out <a href="#">BL131</a>	1.0 to 14.0 pH/0.1 pH	14.0 pH	<p>Maximum Analog Output can be adjusted to a maximum value of 20 mA.            High pH limit is assigned to 20 mA.</p>
Min. Analog Out <a href="#">BL131</a>	0.0 to 13.0 pH/0.1 pH	0.0 pH	<p>Minimum Analog Output can be adjusted to a value of 4 mA.            Low pH limit is assigned to 4 mA.</p>

## ORP Configurable Options

ORP Settings	Range/Options	Default	Description/Menu Navigation
Set Point	200 to 900 mV/1 mV	700 mV	The BL meter will regulate the Chlorine (Cl <sub>2</sub> ) pump operation to get mV value set in this parameter. <ul style="list-style-type: none"> <li>With item selected, press <b>Set</b> to modify.</li> <li>With value flashing, press ▼▲ keys to change the value.</li> <li>Press <b>CFM</b> key to save.</li> </ul>
Proportional Band	10 to 200 mV/1 mV	100 mV	This is a mV range below the ORP Set Point where dosage from the Chlorine pump (Cl <sub>2</sub> ) is regulated to prevent over dosage of chlorine. <ul style="list-style-type: none"> <li>With item selected, press <b>Set</b> to modify.</li> <li>With value flashing, press ▼▲ keys to change the value.</li> <li>Press <b>CFM</b> key to save.</li> </ul>
Dosing Pump	Buit In Remote	Buit In	Setup flow rate for acid/base dosing pump Range: 0.5 to 3.5 l/h Default 2.2 l/h (0.1 l/h increment)
Overtime	1 to 360 min. Disabled	30 min.	Maximum time in minutes the chlorine pump is permitted to continuously run outside the Proportional Band. Within the band, the time increases as the "Pump Off" time increases while approaching the Set Point. <ul style="list-style-type: none"> <li>With item selected, press <b>Set</b> to modify.</li> <li>With value flashing, press ▼▲ keys to change the value.</li> <li>Press <b>CFM</b> key to save.</li> </ul>
Alarm High Value	(Low+1) to 1000 mV/1 mV	900 mV	If enabled, the High Alarm Value for ORP is the minimum mV value that will trigger an alarm status and stop the control pumps (unless in Pool Startup mode). Mask time will delay alarm activation.* Status (●) and service (●) LEDs are active. <ul style="list-style-type: none"> <li>With item selected, press <b>Set</b> to modify.</li> <li>With value flashing, press ▼▲ keys to change the value.</li> <li>Press <b>CFM</b> key to save.</li> </ul>
Alarm High	<input checked="" type="checkbox"/> Enable <input type="checkbox"/> Disable	Disabled	<ul style="list-style-type: none"> <li>With item selected, press the toggle switch to enable or disable ORP high alarm option</li> </ul>
Alarm Low Value	0 to (High-1) mV/1 mV	200 mV	If enabled, the Low Alarm Value for ORP is the maximum mV value that will trigger an alarm status and stop the control pumps (unless in Pool Startup mode). Mask time will delay alarm activation.** Status (●) and service (●) LEDs are active. <ul style="list-style-type: none"> <li>With item selected, press <b>Set</b> to modify.</li> <li>With value flashing, press ▼▲ keys to change the value.</li> <li>Press <b>CFM</b> key to save.</li> </ul>
Alarm Low	<input checked="" type="checkbox"/> Enable <input type="checkbox"/> Disable	Disabled	<ul style="list-style-type: none"> <li>With item selected, press the toggle switch to enable or disable pH low alarm option</li> </ul>

\* The minimum adjustable value for alarm high is related to the value assigned to alarm low (if enabled).

\*\* The maximum adjustable value of alarm low is related to alarm high value (if enabled).

ORP Settings	Range/Options	Default	Description/Menu Navigation
Warnings and Errors	<input checked="" type="checkbox"/> Enable <input type="checkbox"/> Disable	Disabled	<p>If enabled, warnings and errors will be flagging during operation.</p> <p><b>A warning</b> is an event generated when erroneous conditions appear; and when measured values or parameter values are outside the expected range.</p> <p><b>An error</b> is an critical event that requires technical support.</p> <p>A list of these events are listed later in this manual.</p> <ul style="list-style-type: none"> <li>With item selected press the toggle switch to enable or disable notification of ORP events.</li> </ul> <p>The check mark confirms setting as enabled.</p>
Alarm Activates Relay	<input checked="" type="checkbox"/> Enable <input type="checkbox"/> Disable	Disabled	<p>If enabled, the Alarm Relay will be activated if an error or warning condition is detected.</p> <p><b>Note:</b> <i>Warnings and Errors option (above) must be enabled.</i></p> <ul style="list-style-type: none"> <li>With item selected press the toggle switch to enable or disable the relay control for ORP events.</li> </ul> <p>The check mark confirms setting as enabled.</p>
Alarm Mask Time	1 to 999 sec./1 sec.	5 sec.	<p>Mask Time is an alarm delay timer that prevents immediate alarm activation for the time set.</p> <ul style="list-style-type: none"> <li>With item selected, press <b>Set</b> to modify.</li> <li>Press ▼▲ keys to configure value.</li> <li>Press <b>CFM</b> key to save.</li> </ul>
Startup Dosing Delay	1 to 180 min./1 min.	2 min.	<p>This timer is used after powering on the controller and prevents pump dosing for this time period.</p> <ul style="list-style-type: none"> <li>With item selected, press <b>Set</b> to modify.</li> <li>Press ▼▲ keys to configure value.</li> <li>Press <b>CFM</b> key to save.</li> </ul>
Analog Output BL131	Disabled A01, A02, A03	Disabled	<p>Analog Outputs are used as part of process control system. Disabled indicates that analog output has not been allocated to any function.</p> <p>A01, A02, A03 assign an analog output to an ORP reading.</p>
Max. Analog Out BL131	-1999 to 2000 mV/1 mV	2000 mV	<p>Maximum Analog Output can be adjusted to a maximum value of 20 mA.</p> <p>High ORP limit is assigned to 20 mA.*</p>
Min. Analog Out BL131	-2000 to 1999 mV/1 mV	-2000 mV	<p>Minimum Analog Output can be adjusted to a value of 4 mA.</p> <p>Low ORP limit is assigned to 4 mA.*</p>
Cl <sub>2</sub> Tank Input	<input checked="" type="checkbox"/> Enable <input type="checkbox"/> Disable	Disabled	<p>If enabled, works in conjunction with a level detector (user supplied) to notify user when chlorine level is low and requires replenishment.</p> <ul style="list-style-type: none"> <li>With item selected, select Enable or Disable to enable or disable item.</li> </ul> <p>The check mark confirms setting as enabled.</p>

\* The maximum Analog Out must always exceed the minimum Analog Out.

## Temperature Configurable Options

Temp. Settings	Range/Options	Default	Description/Menu Navigation
Alarm High Value	(Low+0.1) to 100.0 °C/0.1 °C (Low+0.1) to 212.0 °F/0.1 °F	50.0 °C 122.0 °F	The High Alarm Value for temperature is the minimum temperature value that will trigger an alarm status and stop the control pumps. Mask time will delay alarm activation.* <ul style="list-style-type: none"> <li>With item selected, press <b>Set</b> to modify.</li> <li>With value flashing, press ▼▲ keys to change the value.</li> <li>Press <b>CFM</b> key to save.</li> </ul>
Alarm High	<input checked="" type="checkbox"/> Enable <input type="checkbox"/> Disable	Disabled	<ul style="list-style-type: none"> <li>With item selected, press the toggle switch to enable or disable Temperature high alarm option</li> </ul>
Alarm Low Value	0.0 to (High-0.1) °C/0.1 °C 32.0 to (High-0.1) °F/0.1 °F	10.0 °C 49.9 °F	The Low Alarm Value for temperature is the minimum temperature value that will trigger an alarm status and stop the control pumps. Mask time will delay alarm activation.** <ul style="list-style-type: none"> <li>With item selected, press <b>Set</b> to modify.</li> <li>With value flashing, press ▼▲ keys to change the value.</li> <li>Press <b>CFM</b> key to save.</li> </ul>
Alarm Low	<input checked="" type="checkbox"/> Enable <input type="checkbox"/> Disable	Disabled	<ul style="list-style-type: none"> <li>With item selected, press the toggle switch to enable or disable Temperature low alarm option.</li> </ul>
Warnings and Errors	<input checked="" type="checkbox"/> Enable <input type="checkbox"/> Disable	Disabled	<p><b>A warning</b> is an event generated when erroneous conditions appear; and when measured values or parameter values are outside the expected range.</p> <p><b>An error</b> is an event that requires technical support. A list of these events are listed later in this manual.</p> <ul style="list-style-type: none"> <li>With item selected press the toggle switch to enable or disable notification of temperature events.</li> </ul> <p>The check mark confirms setting as enabled.</p>
Alarm Activates Relay	<input checked="" type="checkbox"/> Enable <input type="checkbox"/> Disable	Disabled	<p>If enabled, the Alarm Relay will be activated if an error or warning condition is detected.</p> <p><b>Note:</b> <i>Warnings and Errors option (above) must be enabled.</i></p> <p>The check mark confirms setting as enabled.</p>
Unit	°C / °F	°C	Temperature measurement unit
Alarm Mask Time	5 to 999 sec./1 sec.	5 sec.	Mask Time is an alarm delay timer that prevents immediate alarm activation for the time set for temperature related alarms conditions. <ul style="list-style-type: none"> <li>With item selected, press <b>Set</b> to modify.</li> <li>Press ▼▲ keys to configure value.</li> <li>Press <b>CFM</b> key to save.</li> </ul>

\* The minimum adjustable value for alarm high is related to the value assigned to alarm low (if enabled).

\*\* The maximum adjustable value of alarm low is related to alarm high value (if enabled).

Temp. Settings	Range/Options	Default	Description/Menu Navigation
Analog Output (BL131)	Disabled A01, A02, A03	Disabled	Analog Outputs are used as part of the pool control system. Disabled indicates that analog output has not been allocated to any function. A01, A02, A03 assign an analog output to a temperature reading.
Maximum Analog Out (BL131)	-4.0 to 105.0 °C/0.1 °C 24.8 to 221.0 °F/0.1 °F	105.0 °C 221.0 °F	Maximum Analog Output can be adjusted to a maximum value of 20 mA. High temperature limit is assigned to 20 mA.*
Minimum Analog Out (BL131)	-5.0 to 104.0 °C/0.1 °C 23.0 to 219.2 °F/0.1 °F	-5.0 °C 23.0 °F	Minimum Analog Output can be adjusted to a value of 4 mA. Low temperature limit is assigned to 4 mA.*

\* The maximum Analog Out must always exceed the minimum Analog Out.

## Air-temperature Configurable Options

Air-Temp. Settings	Range/Options	Default	Description/Menu Navigation
Air-T	<input checked="" type="checkbox"/> Enable <input type="checkbox"/> Disable	Enabled	<ul style="list-style-type: none"> <li>• With item selected, press the toggle switch to enable or disable air-temperature (Air-T) readings.</li> <li>• The check mark confirms option as enabled.</li> </ul>
Freeze Protection	<input checked="" type="checkbox"/> Enable <input type="checkbox"/> Disable	Disabled	<ul style="list-style-type: none"> <li>• To enable this feature, Air-T option must be enabled.</li> <li>• Freeze-protection mode is used as part of a pool's freeze-prevention system. A relay triggered by reaching the Freeze Threshold setting, activates the recirculation pump. The pump will remain on continuously while the air-temperature is at or below the threshold. This prevents water freezing in the pipes.</li> <li>• Air temperature is monitored and displayed. A snowflake icon indicates air-temperature readings being monitored.</li> <li>• Measurements and normal pool control is still functioning.</li> <li>• The check mark confirms option as enabled.</li> </ul>
Off-Season Mode	<input checked="" type="checkbox"/> Enable <input type="checkbox"/> Disable Test	Disabled	<ul style="list-style-type: none"> <li>• To enable this feature, Air-T option must be enabled.</li> <li>• Off-season mode is used as part of system's off season maintenance. Normal pool control is disabled.</li> <li>• The <a href="#">HI1036-1802</a> electrode can be removed and stored away in a warm location for the winter.</li> <li>• When the air temperature is <b>at</b> or <b>below</b> the Freeze Threshold setting, in Off-Season Mode with freeze protection enabled, the recirculation pump will run continuously.</li> <li>• When the air temperature is <b>above</b> the Freeze Threshold setting, in Off-Season Mode, the recirculation pump will run for 15 minutes at 11:00 daily.</li> <li>• The check mark confirms option as enabled.</li> </ul>
Freeze Threshold	-3.0 to 6.0 °C (28 to 43 °F)	3.0 °C 37 °F	Temperature values lower than configured threshold values trigger (with a 3 minutes delay) the recirculation pump relay. <ul style="list-style-type: none"> <li>• With item selected, press <b>Set</b> to modify.</li> <li>• With value flashing, press <b>▼▲</b> keys to change the value.</li> <li>• Press <b>CFM</b> key to save.</li> </ul>



## 6.4. BL132 HANNA CLOUD SETUP

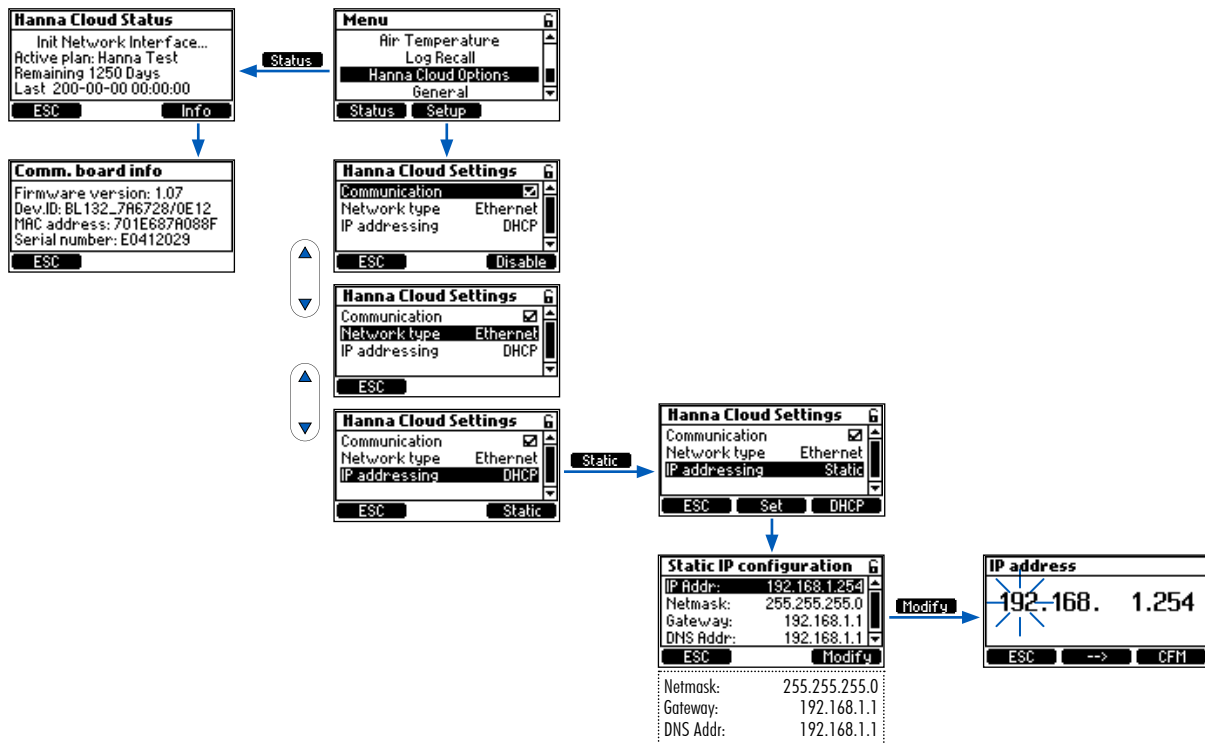

### Hanna Cloud Options

These settings are required to permit Hanna Cloud monitoring.

**IP addressing:** an Internet Protocol address (IP address) is a numerical label assigned to each device connected to a network that uses the IP for communication.

**DHCP** (Dynamic Host Configuration Protocol) is a network management protocol whereby a DHCP server dynamically assigns IP addresses to the instrument.

**Static** means that the installer of the instrument assigns a unique fixed address to the controller. This involves entering:

- a four digit IP address
- a four digit netmask (almost always 255.255.255.0)
- the IP address of the gateway (the router used to connect [BL132](#) to the rest of the internet)
- the IP address of the DNS server

Parameter	Range / Options	Default settings	Description
Communication	<input checked="" type="checkbox"/> Enable <input type="checkbox"/> Disable	Enabled	Option to enable/disable Hanna Cloud communication module
Network Type	Ethernet	Ethernet	<a href="#">BL132</a> network connection type
IP addressing	Static, DHCP	DHCP	Option to select dynamic or static IP address
IP Address	addr01. addr02. addr03. addr04	192.168.1.254	IP address
Netmask	netm01. netm02. netm03. netm04	255.255.255.0	Netmask address
Gateway	gate01. gate02. gate03. gate04	192.168.1.1	Gateway address
DNS Address	dns01. dns02. dns03. dns04	192.168.1.1	DNS server address

## 6.5. PASSWORD PROTECTED SETTINGS

The password protection feature protects against unauthorized configuration changes on the meter and deleting log files. Once set, a series of functions cannot be subsequently modified.

This feature is represented by the lock icon —  — displayed on the functional key or on screen title.

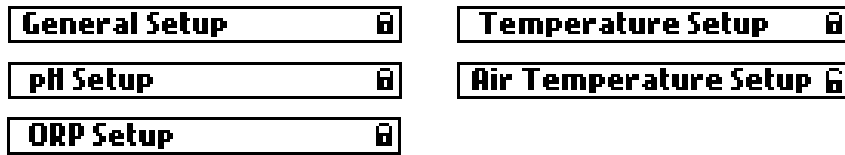

- Select **Controller Password** from General Setup screen and press **Modify** to activate the feature.



- A five digit password has to be entered next.
- To change the digit value, press the **▼▲** keys.
- To move to the next digit, press the arrow functional key.
- Press **CFM** functional key to confirm.

### Disable/change controller password

- Press **▼▲** keys to select **Controller Password** from General Setup.
- Enter the correct password.
- Press **CFM** functional key.  
To change the password
- Enter a new password and press **CFM** functional key.  
To disable the password
- Enter 00000 and press **Disable**.  
Once disabled the open lock icon is displayed .



**Note:** After five failed login attempts, the controller will require a master password. The master password can only be obtained from Hanna Instruments® Service. To issue the master password, Hanna® Service will request the user code displayed at the top of the screen.

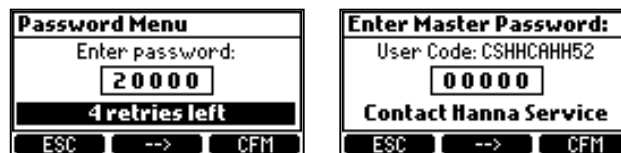

## 6.6. ANALOG OUTPUTS (BL131)

The three 4-20 mA isolated current outputs are factory calibrated and can be configured through the Setup menu as pH/ORP or Temperature outputs.

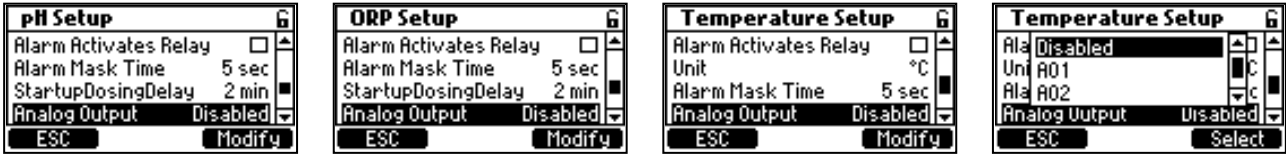

- Each output can be configured to a parameter (or disabled) and can be connected to a chart recorder or data logger.
- The current signal is proportional to the assigned scale of the assigned parameter e.g. A01 → pH, A02 → ORP, A03 → Temperature.
- To assign the output signal, select the minimum and maximum limit values for the parameter (minimum and maximum values are defined in the parameter Setup menu).

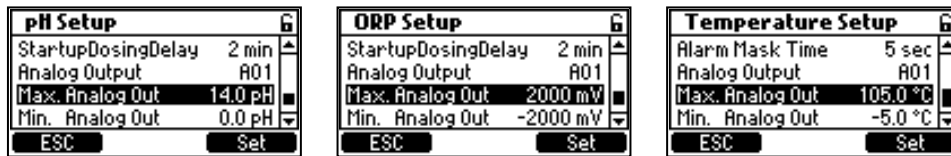

### Example

If the pH was assigned to A01 and the minimum and maximum analog output limits are 0 and 14 pH, the entire range will correspond to 4 and 20 mA, respectively (see Example 1).

A better resolution of analog output can be obtained if the limits are set, thus limiting the range of interest (see Example 2).

Example 1: Range pH 0 - 14

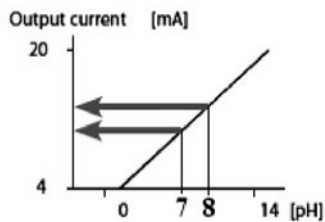

Example 2: Range pH 7 - 8

Advantage: Higher resolution in range of interest

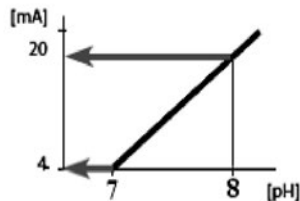

The output current is set to 0 mA when the analog output is disabled.

Under range condition generates 4 mA whereas an over range condition generates 20 mA output current value.

## 7. OPERATIONAL GUIDE

### 7.1. CALIBRATION

#### pH Calibration

The pH electrode can be calibrated on the controller using automatic, two-point calibration.

The electrode should be (re)calibrated:

- Before in-line or flow cell installation
- Whenever the pH electrode is replaced
- When higher accuracy is required
- After periodic maintenance

Always use fresh calibration buffers and perform recommended electrode maintenance prior to calibration.

**Note:** It is recommended to choose calibration buffer solutions that bracket the pH sample.

#### Preparation

- Pour small quantities of the buffer solutions into clean beakers.  
If possible, use plastic beakers to minimize any EMC interferences.  
For accurate calibration and to minimize cross-contamination, use two beakers for each buffer solution; one for rinsing the electrode and one for calibration.
- If measuring in the acidic range, use 7.01 pH as the first buffer and 4.01 pH as the second buffer.
- If measuring in the alkaline range, use 7.01 pH as the first buffer and 10.01 pH as the second buffer.

#### Procedure

A minimum of two-point calibration is required.

- Press **MENU** to enter calibration mode.
- Press **▼▲** keys to select **pH options**.
- Next, press **CAL** functional key. 7.01 pH value is displayed blinking.

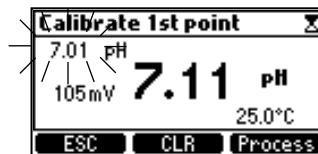

- Remove the electrode protective cap and place the probe into the first buffer solution.
- If the first buffer is 7.01 pH, "Recognized" is displayed followed by "Stable".
- Press **CFM** to accept the first calibration point.

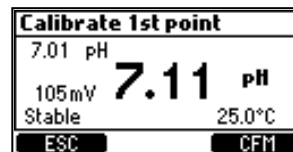
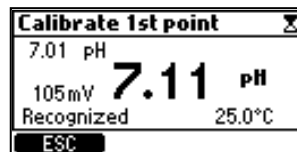

- Place the probe into either pH 4.01 or pH 10.01 calibration buffer.  
4.01 pH value starts blinking automatically.
- If the second buffer is 4.01 pH, "Recognized" is displayed followed by "Stable".
- Press **CFM** to end calibration.  
"pH Calibration Complete" screen is displayed briefly followed by the Menu screen.

- Press **MENU** to return to measurement mode.

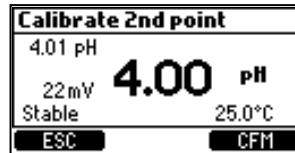
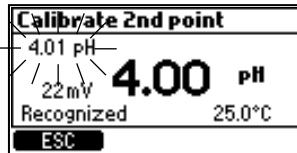

### Delete calibration

- Press **CLR** from calibration screen.  
Device prompts for confirmation
- Press **YES** to confirm or **NO** to exit and return to calibration screen.

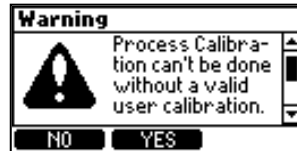

If, during calibration, the temperature sensor detects extreme values, or the sensor broken, a blinking 25.0 °C is displayed (bottom right corner of the screen). This indicates that the controller compensates for this temperature variation.

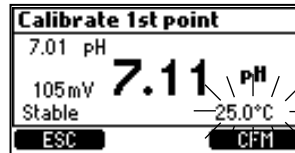

### pH Calibration Error Messages

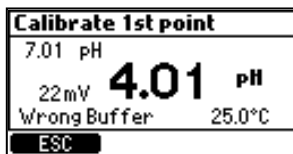

#### Wrong Buffer

Displayed when the difference between the pH reading and the value of the selected buffer is too high.

Check that correct calibration buffer has been used.



#### Invalid Slope

Displayed when the calculated slope is outside of the acceptable range.

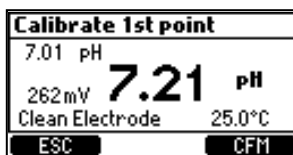

#### Clean Electrode

Message indicates poor electrode performance i.e. offset is outside of the accepted window or slope is under the accepted lower limit.

Clean the probe to improve the pH electrode's response and repeat calibration.

See **ELECTRODE CONDITIONING & MAINTENANCE** for details.

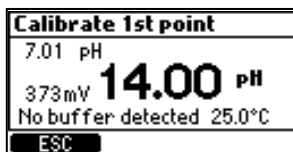

#### No buffer detected

Displayed if the probe has detected no buffer.

## Single-Point pH Calibration

Single-point pH calibration can be performed with the probe installed in the saddle and allows users to adjust the measured pH value so that it matches the value determined with a hand held meter, without removing the probe from the saddle.

Prior to calibration:

- Use a calibrated hand held meter and probe to determine the pH of the pool water.
- Write the value down.

The controller and the probe should have previously been calibrated in two buffers (an electrode slope has been determined).

- Press **MENU** from measurement mode.
- Press the **▼▲** keys to select **pH options**.
- Press **CAL** to enter buffer calibration. Next, press the **Process** key.
- Use the **▼▲** keys to change the calibration point. Press **CFM** to save the calibration.

*Note: The CLR and Process keys are displayed only if the controller and the probe have been previously calibrated on the meter.*

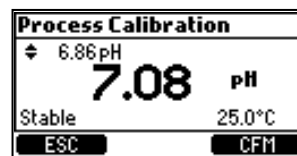

## pH Process Calibration Error Messages

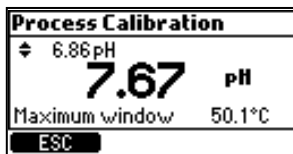

### Maximum window

Displayed if the limits (maximum or minimum) are reached.

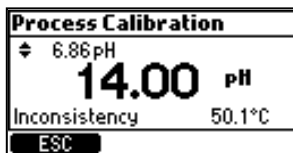

### Inconsistency

Displayed if the pH value is out of range.

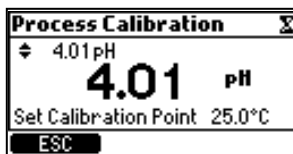

### Set Calibration Point

Displayed if the onscreen value changes when pressing the **▼▲** keys. The displayed set point is automatically set to the current point limits.

## ORP Calibration

If both pH and ORP calibrations are required, calibrate the pH value first. A pH calibration can give inaccurate readings if the probe was used in ORP standard first.

### Preparation

- Pour small quantities of the ORP standard into clean beakers.
- If possible, use plastic beakers to minimize any EMC interferences.
- For accurate calibration and to minimize cross-contamination, use two beakers; one for rinsing the electrode and one for calibration.

### Procedure

- Use the ▼▲ keys to set the value.
- Wait for “Stable” message to be displayed.
- Press **CFM** to confirm calibration. “DONE” message is displayed.

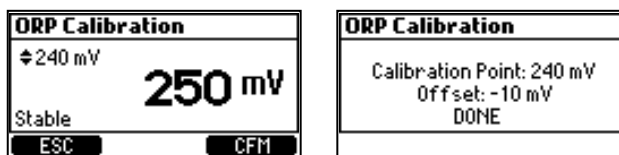

### Delete calibration

- From calibration screen, press **CLR** key to clear a previous calibration.
- The device prompts for confirmation.
- Press **YES** to confirm or **NO** to exit and return in the calibration screen.

A confirmation message is displayed next.

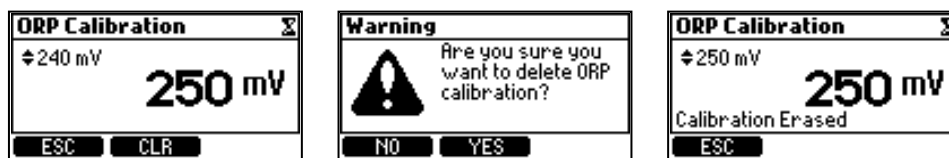

**Note:** Rinse the probe under a running stream of water to remove ORP standard before installing in the saddle or flow cell. It may take several minutes to equilibrate in the pool water after exposure to the ORP standard.

## GLP

Good Laboratory Practice (GLP) refers to a quality control function used to ensure uniformity of probe calibrations and measurements.

- Press **MENU** key.
- Use the ▼▲ keys to select **pH (ORP) options**.
- Press **GLP** key.

If no calibration or the calibration was cleared, “No calibration available” message is displayed.

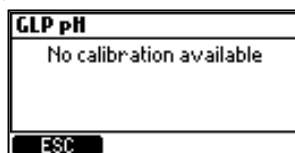

GLP information for pH and ORP is displayed separately.

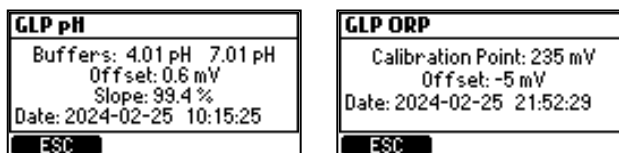

## 7.2. MEASUREMENT

- Start the recirculation pump.
- **BL13X-20 controllers:** verify the flow cell fills correctly.
- Set up the pump controller, probe, and required accessories. Controller is now ready.
- Turn on the controller.

After initialization has been completed, the controller enters measurement screen.

- Select the Manual mode to prime pumps.
- Verify the pumps are functioning properly and tubing connections are not leaking.  
*Note: Fittings may require tightening.*

- Select pH pump, then Chlorine pump, to verify reagents are being pumped.
- To add additional time to Manual pump, press **Add 10s**.
- To verify probe is measuring, press **MENU**.  
pH, mV, and temperature values should be displayed.

Both the pH and Chlorine pumps may be configured as OFF or AUTO.

- To control the pH and disinfection level of the pool automatically, select AUTO for both pumps.
- After setting the pumps, press **MENU** to enter measurement mode.

In Measurement mode, there are three display configurations. Press the ▼▲ keys to navigate configurations.

- **All parameters screen** (default)  
displayed at start up with all measured parameters



- **Single parameter screen** (allows better viewing from a distance)  
pH, ORP, temperature measurements automatically alternate every 3 seconds

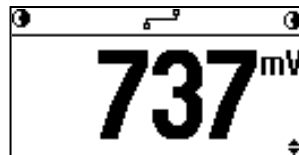

- **24 hour plot screen** (a graphical representation of the measurements taken over the last 24 hours for selected parameter)  
Independent by when the plot is accessed, users can see last 24 hours information.  
*Note: The first and second functional keys are used to change the plotting parameter.*

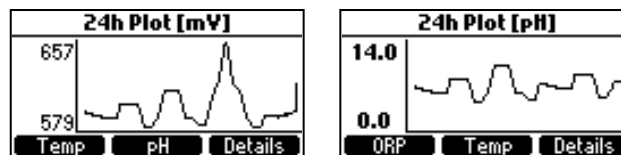

**Details** functional key opens up an overview screen displaying the minimum, maximum, and average values of the measurements taken over the last 24 hours.

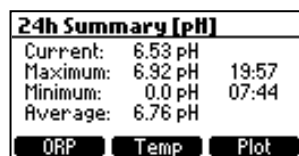



## On-display pump status when in measurement mode, pool startup, and off-season modes

BL131 status bar		BL132 status bar		Description
	MANUAL			Pumps set on OFF
	TANK			Level detection indicates pH and Cl <sub>2</sub> volumes are low
	WAIT pH			System waiting for pH to reach setpoint
	ALARM			Alarm status
	!			Active warnings
	R-HOLD			pH and Chlorine (Cl <sub>2</sub> ) pumps are stopped
				Pool startup
				Freeze protection enabled
	AUTO			Remote pump on AUTO (Cl <sub>2</sub> active)
	HOLD			Hold mode activated (remote pumps).
				Hold mode remotely activated (internal pumps).
				Hold mode remotely activated (remote pumps).

## BL132

## On-display connection status

Icon	Description
	Connecting (connection in-progress)
	Connected (connection established)
	Disconnected; network issues
	Disconnected; cloud connection issues
	Sending messages
	Disabled

### 7.3. OVERVIEW CONTROL MODE

**Control Mode** is the normal operational mode. During control, the device:

- Measures then converts probe's signal to a measurement (temperature corrected pH), the ORP voltage, and temperature.
- Provides proportional feed with an adjustable band for acid and chlorine additions.
- Displays active events on the LCD.
- Activates the LEDs for quick visual feedback.
- Runs pH-ORP control interlock i.e. the ORP control is running only when the pH set point is reached.
- Automatically logs pH / ORP / temperature measurements, last calibration data, setup configuration, event data.
- Allows access to the last 24 hours of data (as a graph) directly from the view mode.
- Automatically logs events.
- Supports data export.

**BL131** only

- Controls the alarm relay and analog outputs as per setup configuration.

**BL132** only

- Sends data to Hanna Cloud.

#### Dosing and remote pump operation mode

- The internal dosing pumps and the remote pumps (activated by the acid or base relay) are regulated through proportional feed. The proportional feed regulates pump's On/Off time within the adjustable band.
- The pump remains on continuously at the setpoint with band added. As the setpoint is approached, the pump is "On" less.
- The **Overtime** safety timer will run during the pump "On" period and is reset when the setpoint is reached.

	pH control	ORP control
Dosing type	ACID / BASE	
Set Point	6.00 – 8.00 pH	200 – 900 mV
Proportional band	0.1 – 2.0 pH	10 – 200 mV

The plot shows how the dosing time is affected by this difference.

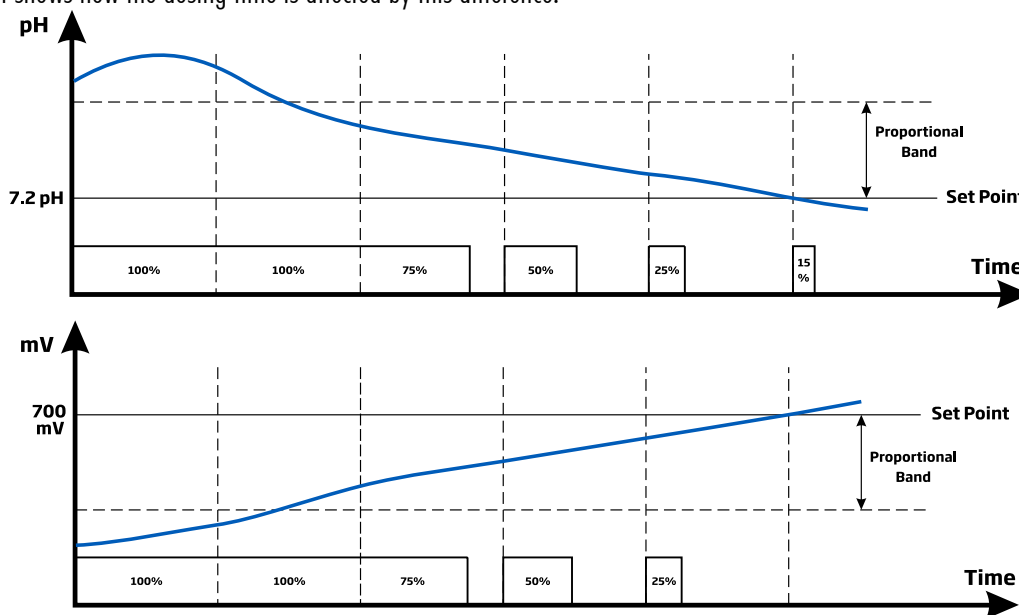

An overview of pH and ORP proportional control is presented in the graph below.

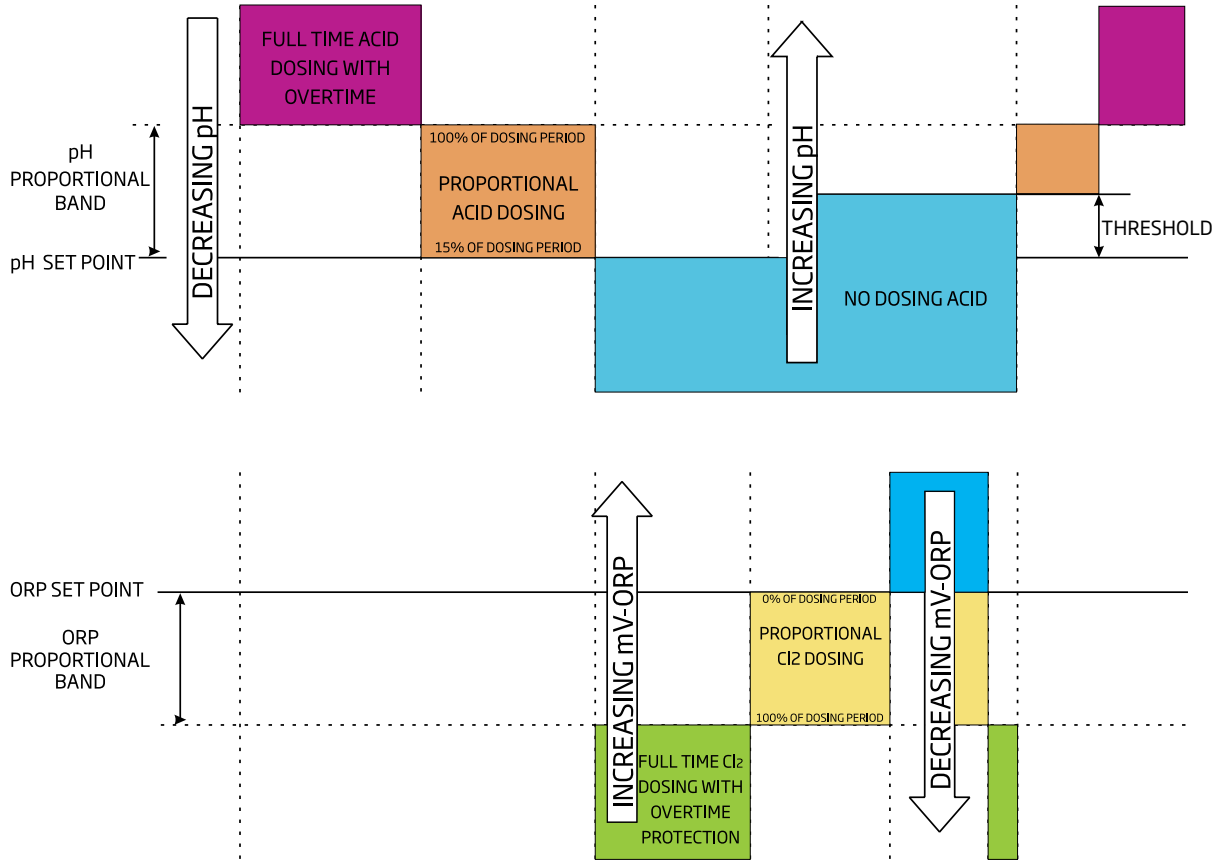

	<p>STATUS ●</p> <p>SERVICE ○</p>
Notification LED	<p>pH/Chlorine internal pump LED → control and pump off ●</p> <p>pH/Chlorine internal pump LED → control and pump running ☀</p> <p><b>Note:</b> if remote pumps are used the ☒ icon is displayed flashing.</p>
Alarm Relay	Energized (no alarms)
BL131 Analog Outputs	Follow configured parameters
Reagent pumps disabled	<ul style="list-style-type: none"> <li>• Immediately after power-on for time configured in pH/ORP Startup Dosing Delay</li> <li>• When acid pump is OFF (manually controlled)</li> <li>• If one or more high/low alarms and/or process errors are active (except during Pool Startup mode)</li> <li>• When the Hold Input or Remote Hold events are active</li> <li>• Pump operation has exceeded time configured in Overtime</li> <li>• During calibration</li> </ul>

### Manual or Auto Pump Control for pH/Chlorine Control

- Select the **OFF** option to set the (each) pump to MANUAL.
- When **On 10s** is selected, the pump runs continuously for 10 seconds.
- Press **Add 10s** button to increase the time up to 90 seconds.

Remaining time is displayed next to the selected pump in the menu or next to the pump on the top bar of the measurement screen.

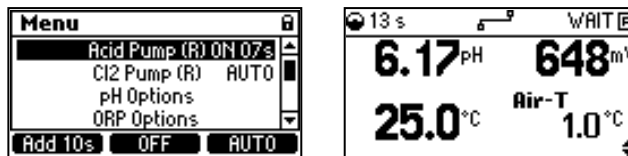

- Press **OFF** to stop the pump.
  - Select **Auto** for each pump to return to automatic mode.
- In Auto mode the pumps will be activated when the measurement reaches the set point value.

## 8. LOGGING

The controller logging system supports periodic and automatic save mode for all parameters as well as an events logging system. The log file stores a maximum of 100 events. Data is stored as per configured time interval. Once the 100 event limit is reached, the oldest logged event is deleted.

A new log is generated if controller ID, date or time, decimal, pH/ORP/Temperature menu configuration change, a calibration, or when the file exceeds 8430 records.

### 8.1. LOG RECALL

The controller can hold up to 100 lots. Logged data can be viewed in standard or plot mode. If the settings change, logs recorded on the same day are displayed with a different index number.

#### View Log Recall

1. Press **MENU** key then use the ▼▲ keys to select **Log Recall** and access logged data.



2. Press **Log Files** to enter Log Recall screen. A logs list is displayed, with the most recent log at the top.



3. Press **Details** to view logged data in standard mode. pH, ORP and temperature values are displayed.
  - Press the ▼▲ keys, to scroll through the records. Current index number is displayed in the right corner of the title bar.
  - Use the right hand function key to view number of samples, date and time, log interval, overtime, hold status, acid/base tank, Chlorine (Cl<sub>2</sub>) tank status.

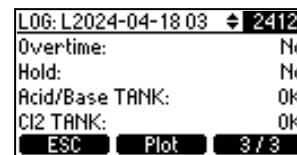
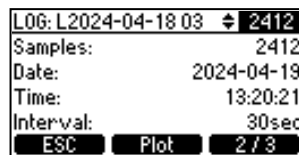
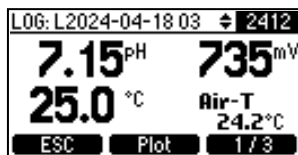

- Press **Plot** to view a day's logged data displayed as a plot. Use the arrow keys to modify the timestamp.
- Press **Details** for further information.

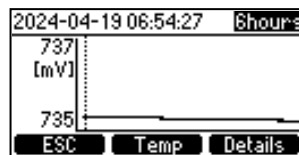
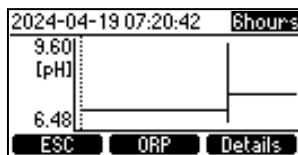

	Min	Max	Avg
pH	6.97	6.97	6.97
ORP	736	736	736
°C	25.0	25.0	25.0

Buttons at the bottom are ESC.

- Press **ESC** key to return to the Log Recall screen.

## Export Logged Data

1. Press **Options** from Log Recall screen. Users have the option to export a selected log file or all logs.



2. Insert the USB-C flash drive.
3. Press **CFM** to continue (**ESC** returns users to a previous screen).

"Transfer in progress" is displayed while the data is transferred and saved to the USB-C flash drive.

Data is saved in a folder named after the controller ID.

"Transfer completed" is displayed when completed.

Press **MENU** key to return to the previous screen.

Logged data is formatted as comma separated values (\*.CSV) and can be opened with any text editor or spreadsheet program.

Click on the desired log to view data.

Logs are designated with year, month, day, index code, and log interval LYMMDDNN <interval> .csv.

E.g. L230810001030s.csv indicates the log with index number 01 from August 10, 2023 with log interval 30 seconds.

Suggested settings for correct formatting: comma or period, Western Europe character set (ISO-8859-1) and English language.

## Delete Logged Data

In Log Recall screen press **Options**. Use the arrow keys and select **Delete all log files**.

Press **CFM** to confirm or press **MENU** key to exit.



## 8.2. EVENT LOG

Alarms, warnings, and errors are logged in the event log. The log has a capacity of maximum 100 events. Recalled events display event index (title bar) and logging date along with time.

### EVENTS OVERVIEW

Type	Definition
<b>(Fatal) Errors</b>	An error is a critical event that requires Hanna Instruments® technical support.
<b>Alarms</b>	<p>An alarm is an event generated when programmed alarm conditions have been met.</p> <p>Configurable triggers:</p> <ul style="list-style-type: none"> <li>• External Hold</li> <li>• Control alarm</li> <li>• Instrument restart</li> <li>• Alarms</li> <li>• Warnings</li> </ul>
<b>Warnings</b>	<p>A warning is an event generated when erroneous conditions appear and when measured values are outside expected range</p> <ul style="list-style-type: none"> <li>• Control warning</li> <li>• User calibration</li> <li>• Process calibration</li> <li>• Setup update</li> </ul>

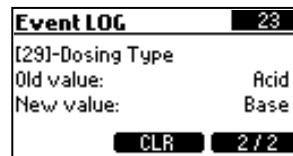
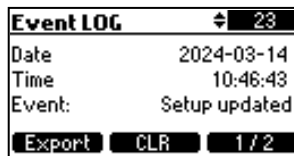
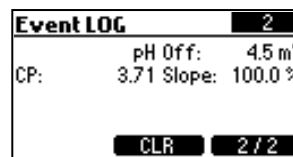
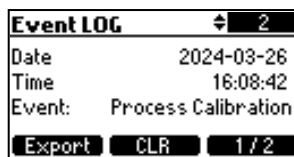
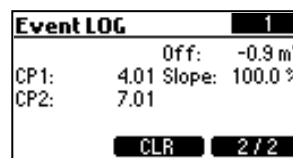
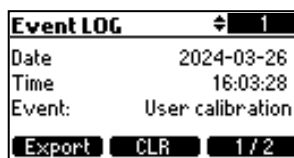

**Note:** The “~~” mark in front of the event type name indicates the event is no longer active.

### Fatal Errors

Errors that prevent the controller from operating (logging). When encountered, restart the controller. If the error persists, contact Hanna Instruments® technical support.

Fatal Error	Event Code	Description
ERROR_EEP_CTRL	0x00001	The interface with the EEP circuit does not work properly. (damaged EEPROM)
ERROR_EEP_SN	0x10000	Serial number checksum error.
ERROR_EEP_AO_CAL	0x20000	AO factory calibration error.
ERROR_3V_POWER	0x00010	3V power failure. (3V power supply out of range)
ERROR_5V_POWER	0x00020	5V power failure. (5V power supply out of range)

Fatal Error	Event Code	Description
ERROR_AO_POWER	0x00100	12V AO power failure. (12V power supply out of range)
ERROR_DI_POWER	0x00800	Digital input power failure.

## Errors

When encountered, restart the controller. If the error persists, contact Hanna Instruments® technical support.

Error	Description
ERROR_EEP_CTRL_CHECKSUM	Incorrect EEPROM checksum.
ERROR_FLASH_CTRL	The interface with the internal storage device is not working properly. Logging stopped, except Event logs.
ERROR_FLASH_CTRL_MFS	System file management error. Log files could be affected. Logging stopped. Event logs are stored correctly. If after restart the error disappears, save log and event files, then delete all files.
ERROR_12V_POWER	12V IO power failure.
ERROR_USB_HOST_POWER	USB interface power failure.
ERROR_MICRO_TEMP	Microprocessor over temperature error. Power off the controller, wait 15 minutes then restart.
ERROR_KTY_COVER_PROTECTION	Motor overheating. Power off the controller, wait 15 minutes then restart.
ERROR_KTY_SHORTINT	Motor drive temperature sensor damaged. Power off the controller, wait 15 minutes then restart.
ERROR_RTC_BATTERY	RTC battery error. Replace the battery.
ERROR_USB_HOST_I	USB input power error.

## Alarms

Alarm	Description
ALARM_HIGH_pH	Generated during measurement when pH reading is over set Alarm High value.
ALARM_LOW_pH	Generated during measurement when pH reading is below set Alarm Low value.
ALARM_HIGH_TEMPERATURE	Generated during measurement when measured temperature is over set Alarm High value.
ALARM_LOW_Temperature	Generated during measurement when measured temperature is below Alarm Low value.
ALARM_OVER_RANGE_pH	Generated during measurement when pH reading is over range specifications.
ALARM_UNDER_RANGE_pH	Generated during measurement when pH reading is under range specifications.
ALARM_OVER_RANGE_ORP	Generated during measurement when mV reading is over range specifications.
ALARM_UNDER_RANGE_ORP	Generated during measurement when mV reading is under range specifications.
ALARM_OVER_RANGE_TEMPERATURE	Generated during measurement when temperature reading is over range specifications.
ALARM_UNDER_RANGE_TEMPERATURE	Generated during measurement when temperature reading is under range specifications.
ALARM_OVERTIME_pH	Generated when measured pH has not reached control Setpoint value after configured time has passed. Place controller on Hold (manually) to reset.
ALARM_OVERTIME_C12	Generated when measured ORP has not reached control Setpoint value after configured time has passed. Place controller on Hold (manually) to reset.
ALARM_PROBE_RECONNECTED	Generated each time probe is reconnected.
ALARM_NO_PROBE	Generated if no probe connected.
ALARM_PROBE_PARAMETER_NOT_LOADED	Probe parameters not fully loaded. Check probe connection/wiring.
ALARM_MAIN_POWER_FAILED	Unplug device from power and reconnect it.
ALARM_PROBE_ERROR	Probe is not measuring/reading correctly.
ALARM_TEMP_SENSOR_BROKEN	Temperature sensor not working.
EXTERNAL_HOLD / ALARM_HOLD_IN	Hold input condition is present. To resume control, fix Hold condition.
ALARM_REMOTE_HOLD_IN	Remote Hold Mode is On. To exit Hold, check & remove hold condition.
ALARM_MAIN_POWER_FAILED	Generated at power Off/On.
ALARM_HIGH_ORP	Measured ORP exceeds Alarm High value.



Alarm	Description
ALARM_LOW_ORP	Measured ORP has dropped below Alarm Low value.
ALARM_OVER_RANGE_ORP	Measured ORP exceeds probe specification range.
ALARM_UNDER_RANGE_ORP	Measured ORP has dropped below probe specification range.
ALARM_LOW_LEVEL_ACID_TANK	pH tank level is too low. Refill the tank.
ALARM_LOW_LEVEL_CL2_TANK	Cl <sub>2</sub> tank level is too low. Refill the tank.
ALARM_EXTT_TEMP_OVERRANGE Air-T	Air temperature has exceeded air-temperature sensor specification.
ALARM_EXTT_TEMP_UNDERRANGE Air-T	Air temperature has dropped below air-temperature sensor specification.
ALARM_EXTT_TEMP_SENSOR_BROKEN	Broken or disconnected Air-T (temperature) sensor.
ALARM_FRONT_COVER_REMOVED	Magnetic faceplate removed.
ALARM_OFF_SEASON_MODE	Off season mode enabled.

## Warnings

Warning	Description
WARNING_NO_pH_UCAL	pH is not user calibrated.
WARNING_NO_ORP_UCAL	ORP is not user calibrated.
WARNING_pH_CONTROL_DELAY	Start up of pH control is delayed. Control is not running.
WARNING_ORP_CONTROL_DELAY	Start up of ORP control is delayed. Control is not running.
WARNING_HIGH_pH	Measured pH exceeds Alarm High value.
WARNING_LOW_pH	Measured pH has dropped below Alarm Low value.
WARNING_HIGH_TEMPERATURE	Measured temperature exceeds Alarm High value.
WARNING_LOW_TEMPERATURE	Measured temperature has dropped below Alarm Low value.
WARNING_HIGH_ORP	Measured ORP above Alarm High value.
WARNING_LOW_ORP	Measured ORP below Alarm High value.
WARNING_pH_PROCESS_CAL_RUN	Access pH process calibration menu.
WARNING_ORP_CAL_RUN	Access ORP calibration menu.
WARNING_OVERTEMP_MOTOR	Motor overheating.
WARNING_LOAD_ETH_FROM_USB	
WARNING_OFFLINE_MSG_FROM_QUEUE	
WARNING_RTC_SET_TO_FIRST_VALUE	
WARNING_LOG_FULL	Log files space is full (100 events recorded). A new file will delete the oldest one. Save all files on a USB flash drive then delete.
WARNING_LOG_MAX_INDEX_ASSIGNED	Too many log files created in one day (100 events logged in one day). Logging stopped until more logging space available. Save all files on a USB flash drive then delete.
WARNING_CLOUD_DOESNT_WORK	Honna Cloud does not work.
WARNING_CLOUD_DISABLED	Hanna Cloud communication is disabled.
WARNING_ANTIFREEZE_ACTIVE	Freeze protection is enabled.

Warnings displayed  
but not logged !

## Setup Codes

BL13X operates an event logging system whereby when setting new parameter values, a Setup event and event code are generated. Log event stores the event code and both new and old values.

Event Code	Setup Parameter
0	Key beep
1	LCD contrast
2	LCD backlight
3	Time format
4	Date format
5	Decimal point
6	Temperature unit
8	Log interval
9	Error beep
10	Language
11	Password enable
13	LCD shut off time
16	Controller ID
17	Setup timeout
19	Controller password
29	pH dosing type
37	Overtime pH
38	Overtime ORP
45	Setpoint pH
46	Setpoint ORP
65	Proportional band pH
66	Proportional band ORP
77	Alarm high pH
78	Alarm high temperature
79	Alarm high ORP
81	Alarm low pH
82	Alarm low temperature
83	Alarm low ORP
97	Alarm high-value pH
98	Alarm high-value temperature
99	Alarm high-value ORP
101	Alarm low-value pH
102	Alarm low-value temperature
103	Alarm low-value ORP

Event Code	Setup Parameter
153	Hold Input Contact
178	Hold Input enable [Hold function enable]
191	A01 parameter to follow
192	A02 parameter to follow
193	A03 parameter to follow
199	A01 value for maximum output
200	A02 value for maximum output
201	A03 value for maximum output
203	A01 value for minimum output
204	A02 value for minimum output
205	A03 value for minimum output
229	pH flow rate
230	Cl <sub>2</sub> flow rate
231	pH warnings & errors enable
232	Temperature warnings & errors enable
233	ORP warnings & errors enable
234	pH alarm activates relay enable
235	Temperature alarm activates relay enable
236	ORP alarm activates relay enable
237	pH tank input enable
238	Cl <sub>2</sub> tank input enable
239	pH startup control delay
240	ORP startup control delay
241	Communication enable
242	Network type
243	IP addressing type
244	IP address
245	Netmask
246	Gateway
247	DNS Address
248	Pool Startup
249	Alarm - Hold input
250	Hold release relay

## Export Event Logs

1. Insert the USB-C flash drive.
2. Press **Export** from Event Log screen to save the event logs file. A confirmation screen appears when the transfer has finished.

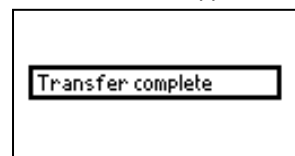
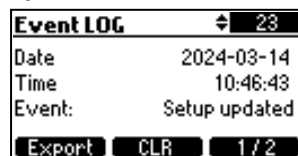

## Delete Event Logs

To clear the event logs file, press **CLR** key. Press **YES** to confirm or **NO** to exit and return to Event Log screen.

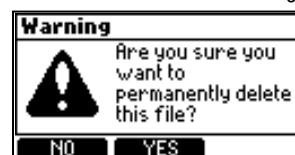
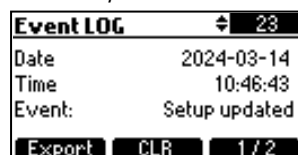

## 9. EVENT MANAGEMENT

BL13X controllers have an intuitive and user-friendly events-management system that allows for quick event source identification. There are four event types filtered using controller Setup options. Press **HELP** key from measurement screen to view all active events.

### EVENT TYPE: WARNING

Triggered by [non-critical events](#)

- [Start-up delay active](#)
  - **pH control delayed** (acid regulator in delay after power-on)
  - **ORP control delayed** (Cl<sub>2</sub> regulator in delay after power-on)
- [High or Low alarm warnings \(Events timeout\)](#)
  - **High or Low warnings for pH/ORP/Temp.**, if alarm is enabled, alarm level exceeded but set timeout value not exceeded
- [pH / ORP / Temperature warning events](#), if enabled only; do not affect dosing, alarm relays, buzzer
- [BL132 Cloud connectivity issues](#)
  - **Communication disabled**
  - **No connection to Hanna Cloud**

### EVENT TYPE: ALARM

Triggered by [measured data exceeding configured high or low limits](#)

Values are user selectable, and enabled or disabled from the parameter option Setup Menu.

- [Evaluation criteria](#)
  - Alarm condition is evaluated only if condition is enabled.
  - Alarm evaluation is done at 1 second interval after a new measurement cycle.
- [Mask Time](#)
  - An alarm is delayed as per configured Mask Time and is issued as a warning until configured period has elapsed. After that a warning becomes an alarm.
  - If a warning condition continues after the configured Mask Time has elapsed, the warning becomes an alarm.
- [Alarm Relay](#)
  - An active alarm deenergizes the **Alarm Relay** if the **Alarm Activates Relay** is enabled.  
e.g. for pH errors "Menu \ pH options \ Alarm Activates Relay
- [Acoustic signal](#)
  - If **Alarms and Errors Beep** is enabled, an acoustic signal is issued each time an alarm is triggered
- [Logging](#)
  - Alarms are logged and recalled from **Log Recall**.

*Note: The logging period lasts longer than the measure period. Any alarm condition that occurred between logging is recorded and logged even if the alarm conditions are no longer active on first log (event) after the alarm.*
- [On-screen symbols](#)
  - (☯) high or (⊕) low-alarm icon is displayed close to parameter value which triggered the alarm.
- [On-screen messages](#)
  - The ALARM message is displayed close to the pump icon.
  - Help on measurement screens displays the active alarms.

**EVENT TYPE: ERROR**

Triggered during process control and affects pH and/or ORP control

A condition is evaluated only if it's enabled. See noted exceptions.

**Note:** "No probe", "Hold input active", and "Remote Hold " are not dependent on "Warnings and Errors  " settings.

Errors are logged and viewed in Log Recall. After an error has been triggered, an error message is displayed next to the pump icon:

- ERROR — Out of range and overtime errors
- TANK — Low level in Acid/Base and/or Cl<sub>2</sub> tanks
- R-HOLD blinking — Hold mode remotely activated
- HOLD — Hold input (recirculation pump)
- Help accessed from measurement screen displays active errors

**EVENTS**

- No user calibration
  - No pH or ORP user calibration (calibration cleared), if Menu\pH (ORP) options\Warnings and Errors
- Pump control disabled due to overheating
  - Overheating dosing delay active, if the pump driver temperature is above accepted limit
- Out of range
  - pH out of range if "Menu\pH options \ Warnings and Errors
  - ORP out of range if "Menu\ORP options \ Warnings and Errors
  - Temperature out of range if "Menu \ Temperature options \ Warnings and Errors

- Hold input active, if Hold input is enabled

**Note:** the recirculation pump doesn't work.

- Remote hold active

Remotely triggered (notification message displayed) when remote Hold (R-HOLD) option is enabled.

Press YES to exit Hold mode.

Alternatively, press R-HOLD (Menu\Hanna Cloud options) to cancel the hold at a later stage.

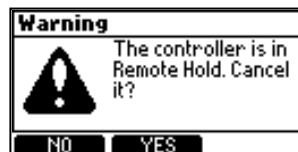

**Note:** BL122 & BL123 pumps are deactivated.

R-HOLD deactivation function is password protected, if controller password has been correctly configured in General Setup.

- Tank level input active

If "Menu \ pH options \ Setup \ Warnings and Errors

- Low level in acid/base tank if "Menu \ pH options \ Setup \ Acid/base Tank Input
- Low level in Cl<sub>2</sub> tank if "Menu \ ORP options \ Setup \ Cl<sub>2</sub> Tank Input

**Note:** Level errors triggered only when a level sensor is used.

- Overtime

- pH (ORP) dosing overtime if acid (Cl<sub>2</sub>) pump is dosing full time or in proportional control band for more than configured value.  
Go to: "Menu\pH (ORP) options\Setup\Overtime xxxmin"

**Note:** Overtime errors are cleared only at controller restart or via Manual control.

The overtime counters are reset when Hold Input is active.

- No probe, if probe is disconnected
- Power failure

**EVENT TYPE: SYSTEM ERROR**

Triggered by *critical events*, place the controller in **ERROR mode**. Events are continuously monitored.

When in ERROR mode, the device:

- Stops the dosing pumps
- Stops logging
- Activates the alarm relay (relay not energized)
- Issues repetitive acoustic signals
- Displays an error code (the OR of all errors detected) and access to the device is blocked.



**Note:** If *Alarms and Errors Beep* is enabled, an acoustic signal is issued each time an error is triggered.

*A measurement alarm will shut off if the measurement reaches the setpoint within the overtime timer period.*

## LED NOTIFICATIONS ON CONTROLLER STATUS

LED type	LED notifications		Description
	Solidly illuminated	Flashes	
STATUS LED	●	not present	system running, no events
	●	not present	system requires user attention
	not present	✱	technical assistance required
SERVICE LED	not present	✱	service required
pH & Cl <sub>2</sub> pump LEDs (condition dependent)	●	✱ (✱)	
Pump in Manual (condition dependent)	●	✱ (✱)	

Note: LED off ○

Pump running	Events	Dosing pump status with associated LED signal				STATUS LED	SERVICE LED
		pH pump	pump LED	Cl <sub>2</sub> pump	pump LED		
Pump in Auto	Dosing delay at start-up	Off	●	Off	●	●	○
	No dosing	Auto-Off	●	Auto-Off	●	●	○
	Dosing Acid	Auto-On	✱	Auto-Off	●	●	○
	Dosing Chlorine	Auto-Off	●	Auto-On	✱	●	○
Pump in Manual	pH	Active high/low alarm	Manual Off/On	✱	Auto-Wait	○	✱
		No active alarm	Manual Off/On	✱	Auto-Wait	●	✱
	Cl <sub>2</sub>	Active high/low alarm	Auto-Wait	○	Manual Off / On	✱	✱
		No active alarm	Auto-Wait	●	Manual Off / On	✱	✱
Warning	pH	Active high-pH level warning	Auto-On	✱	Off	●	○
		Active low-pH level warning	Auto-Off	●	On	(✱)	○
	ORP	Active high-ORP level warning	Auto-Off	●	On	●	○
		Active low-ORP level warning	Auto-Off	●	On	✱	○
	Temp.	Active high/low temp. warning	Auto	(✱)	Auto	(✱)	○
Pool startup	No alarms	Auto	✱	Auto	●	●	○
Logging (all parameters)	No logging, no alarms	Auto	(✱)	Auto	(✱)	●	✱
Cloud connectivity	No connectivity, no alarms	Auto	(✱)	Auto	(✱)	●	✱

Hold mode	Events	Dosing pump status with associated LED signal				STATUS LED	SERVICE LED
		pH pump	pump LED	Cl <sub>2</sub> pump	pump LED		
	In-progress pH or ORP user calibration	Off	○	Off	○	●	✱
	In-progress setup settings configuration	Off	○	Off	○	●	✱

Manual mode	Events	Dosing pump status with associated LED signal				STATUS LED	SERVICE LED
		pH pump	pump LED	Cl <sub>2</sub> pump	pump LED		
Acid (base) pump control On	Active high/low alarm	Manual On	✱	Manual Off	○	✱	✱
	No alarm	Manual On	✱	Manual Off	○	●	✱
Chlorine pump control On	Active high/low alarm	Manual Off	○	Manual On	✱	✱	✱
	No alarm	Manual Off	○	Manual On	✱	●	✱
Acid & Chlorine pump control On	Active high/low alarm	Manual On	✱	Manual On	✱	✱	✱
	No alarm	Manual On	✱	Manual On	✱	●	✱
No probe connected	"No probe connected" warning display	Manual	(✱)	Manual	(✱)	✱	✱

Alarm & Errors		Events	Dosing pump status with associated LED signal				STATUS LED	SERVICE LED
			pH pump	pump LED	Cl <sub>2</sub> pump	pump LED		
High/Low Alarm	pH		Auto-Off	○	Auto-Off	○	✖	☀
	ORP		Auto-Off	○	Auto-Off	○	✖	☀
	Temperature		Auto-Off	○	Auto-Off	○	✖	☀
Measured parameter under/over range	pH outside specifications range		Auto-Off	○	Auto-Off	○	✖	☀
	ORP outside specifications range		Auto-Off	(✖)	Auto-Off	○	✖	☀
	Temperature outside hardware range		Auto-Off	(✖)	Auto-Off	(✖)	✖	☀
Calibration	No Factory Calibration		Auto-Off	○	Auto-Off	○	✖	☀
	No User Calibration		Auto-Off	○	Auto-Off	○	✖	☀
	No probe		Auto-Off	○	Auto-Off	○	✖	☀
Overtime	pH	Active high/low alarm	Auto-Off	○	Auto-Off	○	✖	☀
		No alarm	Auto-Off	○	Auto-Off	○	●	☀
	Cl <sub>2</sub>	Active high/low alarm	Auto-Off	○	Auto-Off	○	✖	☀
		No alarm	Auto-Off	(✖)	Auto-Off	○	●	☀
Low tank-level	Acid	Active high/low alarm	Auto-Off	○	Auto-Off	○	✖	☀
		No alarm	Auto-Off	○	Auto-Off	○	●	☀
	Cl <sub>2</sub>	Active high/low alarm	Auto	○	Auto-Off	○	✖	☀
		No alarm	Auto	(✖)	Auto-Off	○	●	☀
Hold Input	Active high/low alarm	Auto-Off	○	Auto-Off	○	✖	☀	
Hold Alarm Disabled	No alarm	Auto-Off	○	Auto-Off	○	●	○	
Hold Input	Active high/low alarm	Auto-Off	○	Auto-Off	○	✖	☀	
Hold Alarm Enabled	No alarm	Auto-Off	○	Auto-Off	○	●	☀	
Remote Hold	Device place on hold remotely	Auto-Off	○	Auto-Off	○	●	☀	
System error	Critical hardware errors	Off	○	Off	○	✖	☀	

**Note:** Placing the system on Hold Input stops data measurement and logging. The other warnings and events do not stop measurement. Logging is supported throughout, apart from when controller is configured as not logging or a hardware error stops logging.

## 10. MAINTENANCE

### 10.1. ELECTRODE CONDITIONING & MAINTENANCE

#### Preparation

- Remove the electrode protective cap.
- Rinse any salt deposits with water.
- Shake down the probe to eliminate any air bubbles trapped inside the glass bulb.
- If the bulb and/or junction are dry, soak the electrode in [HI70300](#) Storage solution for at least one hour.

#### Storage

- To minimize clogging and ensure a quick response time, the glass bulb and the junction should be kept hydrated and not allowed to dry out. This can be achieved by installing the electrode in such a way that it is constantly in the flow cell or the pipe filled with the sample.
- When not in use, replace the solution in the protective cap with a few drops of [HI70300](#) Storage solution or, in its absence, [HI7082](#) KCl 3.5M solution.
- Follow the Preparation procedure above before taking any measurements.

**Note:** Never store the electrode in distilled or deionized water.

### 10.2. PUMP TUBING REPLACEMENT



#### General safety considerations

Always wear protective clothing, including gloves and eye protection when replacing pump tubing.

1. Power off the controller.
2. Disconnect the tubing from the pumps.

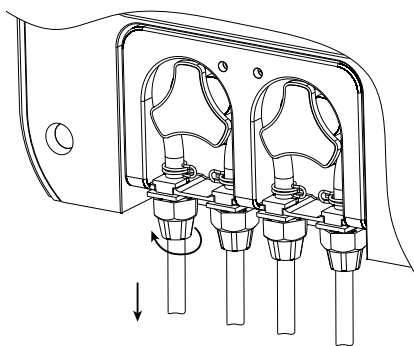

3. Starting from the left side of the pump grab the tubing and rotate the pump rotor manually to the right, until the tubing is removed.

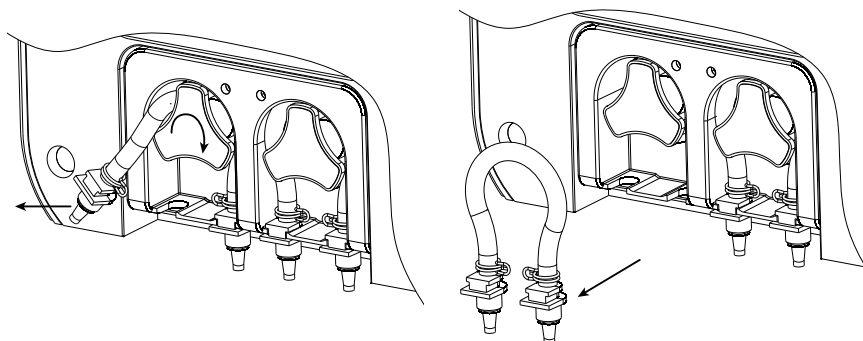

4. Grease the replacement pump tubing with silicone oil supplied in the [BL120-300](#) peristaltic pump tubing kit.



5. Place the tubing on the left side of the pump and start to manually rotate the pump rotor to the right until the tubing is on the pump.
6. Fix the plastic holder in its place on the right and left side.

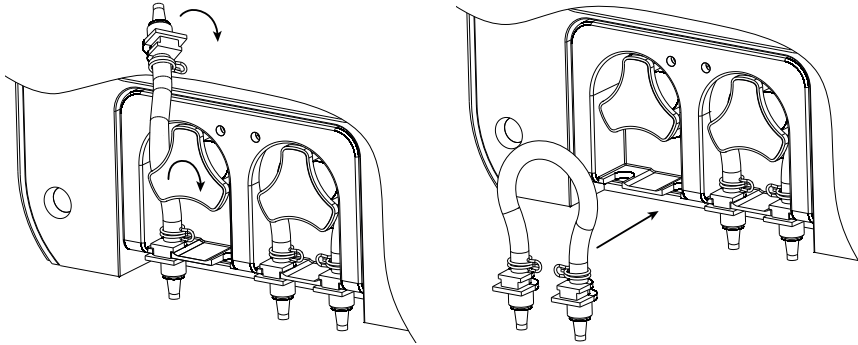

7. Reconnect the tubing to the pumps.

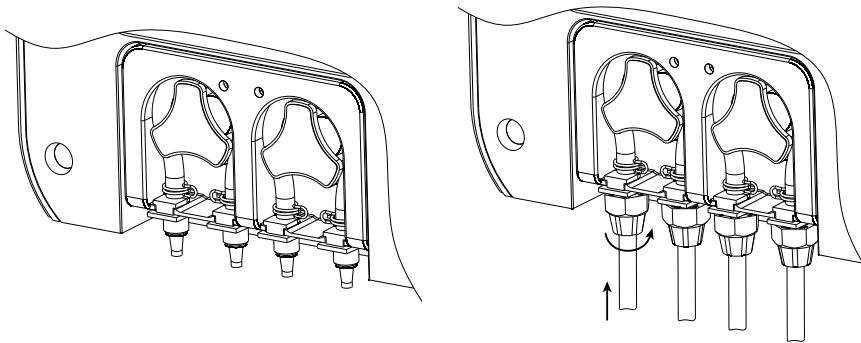

## 11. ACCESSORIES

### Probes

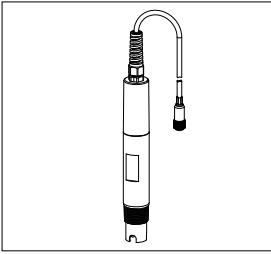

**HI1036-18XX \***  
 Industrial pH / ORP /  
 Temperature / Matching Pin  
 combined probes  
 \* XX = attached cable length  
 02, 05, 10, 15, 20 (m)

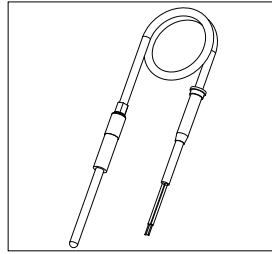

**BL130-900**  
 Ambient Temperature Probe for  
**BL131, BL132**  
 1 m (3.3') cable

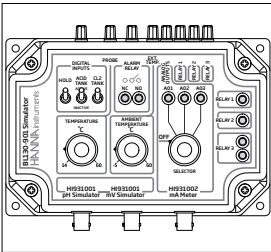

**BL130-901**  
 Simulator for **BL131** and **BL132**

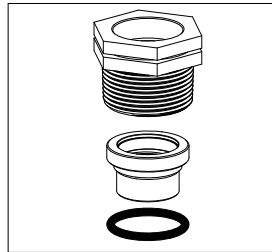

**BL120-500**  
 Probe fitting kit

### Peristaltic pump

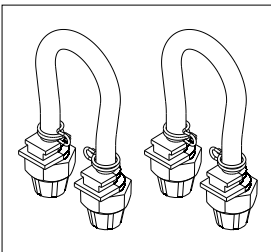

**BL130-300**  
 Pool controller peristaltic pump  
 tubing kit (2 pcs.)

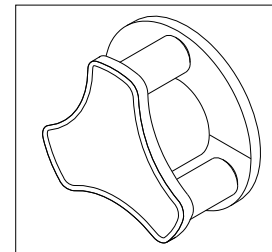

**BL130-301**  
 Pool controller peristaltic pump  
 rotor

### Injectors and Fittings

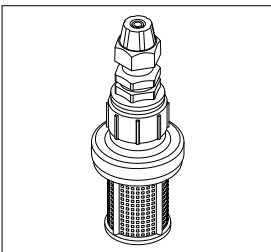

**BL120-200**  
 Pool controller aspiration filter

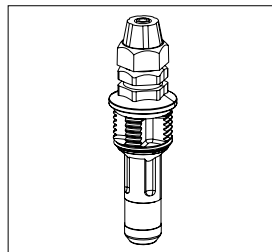

**BL120-201**  
 Pool controller injector,  
 1/2" thread

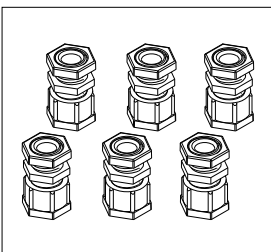

**BL120-903**  
 Cable gland protective kit  
 (6 pcs.)

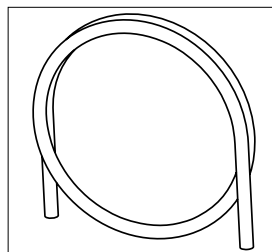

**BL120-202**  
 PVC aspiration and injection  
 tubing (10 m)

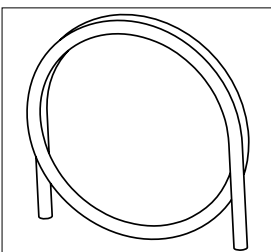

**BL120-204**  
 Aspiration tubing (100 m)

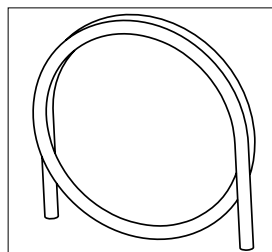

**BL120-205**  
 Injection PE tubing (100 m)

Flow Cell Saddle and Fittings

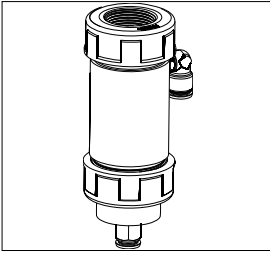

**BL120-410**  
Flow cell for  
BL131, BL132, and  
BL120, BL121, BL122, BL123

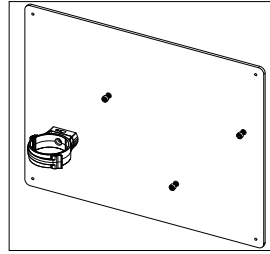

**BL130-411**  
Flow cell panel spare part

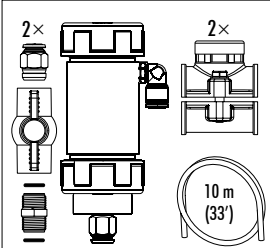

**BL120-450**  
Flow cell kit for Ø 50 mm pipe

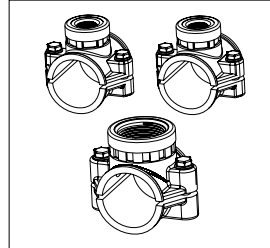

**BL120-150**  
Saddle kit for Ø 50 mm pipe  
contains:  
• injector saddle (2 pcs.)  
• probe saddle

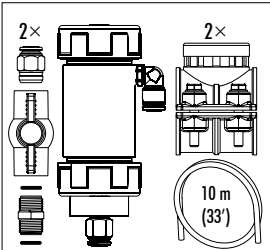

**BL120-463**  
Flow cell kit for Ø 63 mm pipe

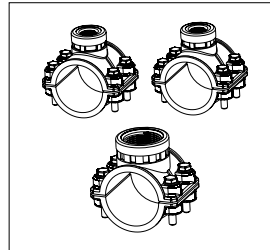

**BL120-163**  
Saddle kit for Ø 63 mm pipe  
contains:  
• injector saddle (2 pcs.)  
• probe saddle

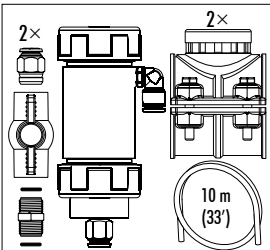

**BL120-475**  
Flow cell kit for Ø 75 mm pipe

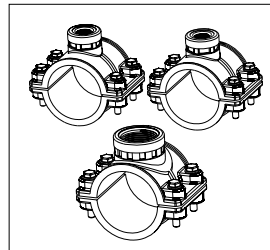

**BL120-175**  
Saddle kit for Ø 75 mm pipe  
contains:  
• injector saddle (2 pcs.)  
• probe saddle

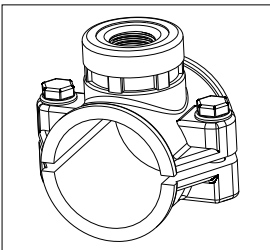

**BL120-250**  
Injector saddle for Ø 50 mm  
pipe, 1/2" thread

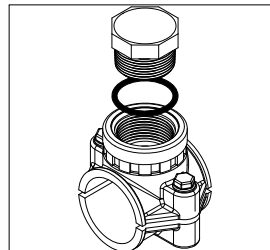

**BL120-550**  
Probe saddle for Ø 50 mm pipe,  
1 - 1/4" thread

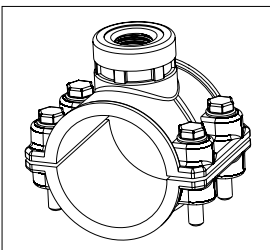

**BL120-263**  
Injector saddle for Ø 63 mm  
pipe, 1/2" thread

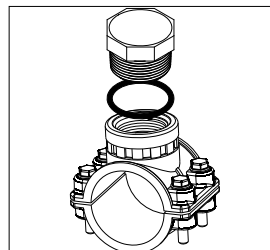

**BL120-563**  
Probe saddle for Ø 63 mm pipe,  
1 - 1/4" thread

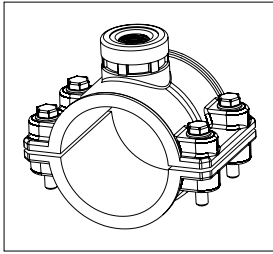

**BL120-275**  
Injector saddle for  $\varnothing$  75 mm  
pipe,  $\frac{1}{2}$ " thread

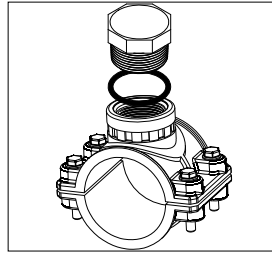

**BL120-575**  
Probe saddle for  $\varnothing$  75 mm pipe,  
 $1 - \frac{1}{4}$ " thread

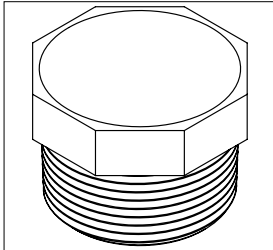

**BL120-501**  
Protective saddle cap,  
 $1 - \frac{1}{4}$ " thread

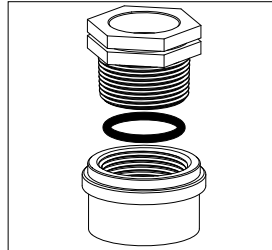

**BL120-400**  
Flow cell probe adapter kit

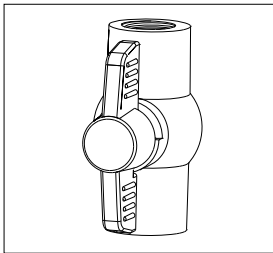

**BL120-401**  
Flow cell valve

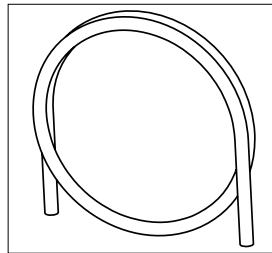

**BL120-402**  
Flow cell tubing, (10 m)

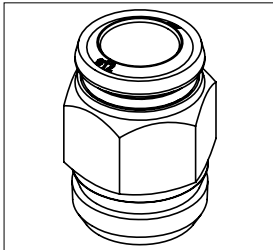

**BL120-602**  
Metal nipple  $12 \times \frac{1}{2}$ "  
(2 pcs.)

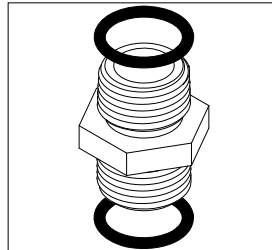

**BL120-601**  
Plastic nipple  $2 \times \frac{1}{2}$ "  
with O-rings

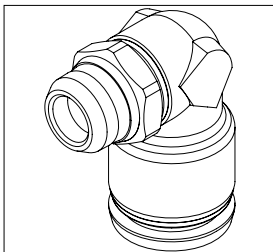

**BL120-603**  
Elbow for glass flow cell

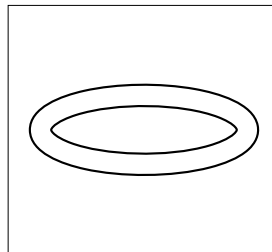

**BL120-604**  
O-ring for glass flow cell

### Beaker Set

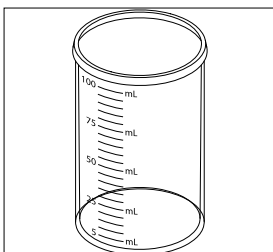

**HI740036P**  
Plastic beaker set, 100 mL  
(10 pcs.)

## Electrode Storage Solutions

HI70300L	Storage solution, 500 mL
----------	--------------------------

## Buffer Solutions

HI70004P	pH 4.01 buffer sachets, 20 mL (25 pcs.)
HI70007P	pH 7.01 buffer sachets, 20 mL (25 pcs.)
HI70010P	pH 10.01 buffer sachets, 20 mL (25 pcs.)
HI7004L	pH 4.01 buffer solution, 500 mL
HI7007L	pH 7.01 buffer solution, 500 mL
HI7010L	pH 10.01 buffer solution, 500 mL

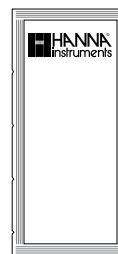

## ORP Solutions

HI7021L	ORP test solution, 240 mV @ 25 °C, 500 mL
HI7022L	ORP test solution, 470 mV @ 25 °C, 500 mL
HI7091L	Reducing pre-treatment solution for ORP electrodes, 500 mL + 14 g (set)
HI7092L	Oxidizing pre-treatment solution for ORP electrodes, 500 mL
HI70022P	ORP test solution, 470 mV @ 25 °C, 20 mL (25 pcs.)

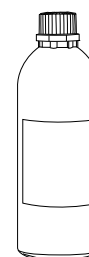

## 12. ABBREVIATIONS

**DHCP** Dynamic Host Configuration Protocol

**IP** Internet Protocol (address)

**LED** Light Emitting Diode

**ORP** Oxidation-Reduction Potential

**REDOX** Reduction & Oxidation

**SPDT** Single Pole Double Throw

## CERTIFICATION

All Hanna® instruments conform to the CE European Directives and UK standards.



**Disposal of Electrical & Electronic Equipment.** The product should not be treated as household waste. Instead, hand it over to the appropriate collection point for the recycling of electrical and electronic equipment, which will conserve natural resources.

**Disposal of waste batteries.** This product contains batteries, do not dispose of them with other household waste. Hand them over to the appropriate collection point for recycling.

Ensuring proper product and battery disposal prevents potential negative consequences for the environment and human health, which may be caused by inappropriate handling. For more information, contact your city, your local household waste disposal service, or the place of purchase.

## RECOMMENDATIONS FOR USERS

Before using this product, make sure it is entirely suitable for your specific application and for the environment in which it is used. Any variation introduced by the user to the supplied equipment may degrade the controller's performance. For your and the controller's safety do not use or store the controller in hazardous environments.

## WARRANTY

This controller is warranted for two years (the probe for six months) against defects in workmanship and materials when used for its intended purpose and maintained according to instructions. This warranty is limited to repair or replacement free of charge. Damage due to accidents, misuse, tampering or lack of prescribed maintenance is not covered.

If service is required, contact your local Hanna Instruments® office. If under warranty, report the model number, date of purchase, serial number (engraved on the bottom of the meter) and the nature of the problem. If the repair is not covered by the warranty, you will be notified of the charges incurred. If the instrument is to be returned to Hanna Instruments, first obtain a Returned Goods Authorization (RGA) number from the Technical Service department and then send it with shipping costs prepaid. When shipping any instrument, make sure it is properly packed for complete protection.